

FLOORS WITH CHARACTER.



CHECK ✓

TO BE ON THE SAFE SIDE

check-floors.com

Discover the
diverse product world
of CHECK.

CHECK ✓ one

Vinyl floors in plank, wide plank, herringbone and tile format for clicking.

BASIC COLLECTION
STANDARD COLLECTION
PREMIUM COLLECTION

From page 12

CHECK ✓ comfort

Comfort floors in wide plank, wide and long plank format for clicking.

COMFORT COLLECTION

From page 88

World of SPC

by CHECK ✓

Vinyl floors in plank, wide plank, herringbone and tile format for clicking.

VILLAGE COLLECTION
TOWN COLLECTION
1x4 COLLECTION

From page 116

CHECK ✓ expert

Dryback floors in plank, wide plank, long and wide plank as well as XL tile format.

STANDARD COLLECTION
PREMIUM COLLECTION

From page 74

CHECK ✓ green

Design floors in plank and tile format for clicking.

GREEN COLLECTION

From page 106

World of DRYBACK

by CHECK ✓

Vinyl floors in wide plank, and herringbone format for bonding.

TOWN COLLECTION Page 126
1x4 COLLECTION Page 134

Good Reasons for CHECK —

THE FLOORING WITH CHARACTER.

The CHECK vinyl and design floors prove to be a robust and durable option for creating beautiful and healthy living spaces.

A major advantage of CHECK is its high dimensional stability, which enables installation on existing sub-floors, in residential conservatories and by floor-to-ceiling windows. Thanks to harmless plasticizers, our floors also ensure a healthy living environment. Due to the insensitive surface, they are very hard-wearing and easy to clean. With their low construction height of 4.0 mm to 8.0 mm, the CHECK products stand out as optimal renovation floors for every need. The vinyl and design floors can also be installed in bathrooms and kitchens without hesitation, as moisture is guaranteed not to penetrate through the water resistant properties.* The CHECK floors can be installed either by click system or glueing.*



*** www.blauer-engel.de/uz176 ***

For more information, please visit check-floors.com

* Product specifications observation

*** CHECK green

**Indication of the level of emissions of volatile substances in the ambient air presenting a toxic risk by inhalation on a scale from A+ (very low emission) to C (high emission).

**Information sur le niveau D'émission de substances volatiles dans l'air intérieur, présentant un risque de toxicité par inhalation sur une échelle de classe allant de A+ (très faibles émissions) à C (fortes émissions).



“If you are looking for a floor with character that is also technically convincing, CHECK is the right choice for you.”
Andreas Koczvara, Managing Director

**15 YEAR
GUARANTEE**
according to guarantee conditions

✓ SUITABLE FOR DAMP ROOMS*

CHECK is a real all-rounder that can also be installed in damp rooms, such as the bathroom.

✓ HEAT RESISTANT*

The floors remain dimensionally stable and can therefore be installed in residential conservatories and by floor-to-ceiling windows.

✓ HARD-WEARING.*

The CHECK surfaces can withstand all residential, commercial and industrial use.

✓ AUTHENTIC

The surfaces not only look like real wood or stone, but they also feel like it. It makes the floor a real eye-catcher.

✓ STABLE

Slight unevenness in the subfloor can be compensated for and telegraphing can be avoided, so that installation is even possible on existing tiles.

✓ HEALTHY LIVING

By dispensing with phthalates, and the use of exclusively harmless plasticizers, CHECK ensures healthy living within your own four walls.

* according to manufacturer's approval / product specifications observation



CHECK – full of character
down to the last detail



For more quality of living

Whether the children are running around the room or the dog is dashing from one corner to the other – our floor has to meet many demands in everyday life. The CHECK vinyl and design floors make a valuable contribution to this, because they can now also reduce walking noise and are even warmer and easier on the joints than conventional floors.

The new collection from CHECK impresses with a built-in insulation underlay that

reduces impact sound by up to 21 dB. The products thus guarantee a very pleasant walking sensation and, in addition, can be laid even faster and more cost-effectively. The clever product design ensures pleasant foot warmth and is gentle on the joints at the same time. Divided into the different collections Basic, Standard and Premium, the products promise a high quality standard that can withstand the greatest stresses.

UP TO 21 DB
IMPACT SOUND
REDUCTION

OTHER STRONG CHARACTER ADVANTAGES



QUIET

The integrated impact sound underlay ensures optimal room acoustics, minimises walking noise by up to 21 dB and thus contributes to a special walking comfort.



FOOT WARMTH

The clever product design of the CHECK-floors ensures a pleasant warmth and makes the floor even more comfortable.



PROTECTS JOINTS

The design of the ABA products (see p. 91) relieves the joints when walking – a blessing for anyone who struggles with joint pain from time to time.



Pictogram overview

-  PLANK
-  WIDE PLANK
-  LONG & WIDE PLANK
-  TILE
-  XL-TILE
-  HERRINGBONE
-  4V GROOVE
-  BEVELLED EDGE
-  INCL. INTEGRATED UNDERLAY
-  MATT FINISH
-  SUPER-MATT FINISH
-  HIGH GLOSS FINISH
-  SYNCHRONOUS EMBOSSING
-  UTILISATION CLASS
-  LOC-CLICK
-  INNOVATION-CLICK
-  FOLD DOWN
-  BONDING

You can find more detailed explanations of our pictograms on page 141.

CHECK ✓ one

**15 YEAR
GUARANTEE**
according to guarantee conditions



” CHECK combines attractive and natural decors with high quality standards. “
Timo Paulowski, Sales



· suitable for floor-to-ceiling windows and residential conservatories *



· Plasticizer-free carrier board



· suitable for damp rooms *



· hard-wearing



· Selected floors incl. integrated underlay



· suitable for hot water underfloor heating *

THE NEXT GENERATION

Vinyl floors of the CHECK one series have a harder carrier board, which makes the click connections more stable. As a result, they can also be laid in places where conventional vinyl flooring could soften due to heat, for example by floor-to-ceiling windows or in residential conservatories.* It is no longer necessary to acclimatise the material to the room climate before installation.

CHECK one floors are also very hard-wearing and are therefore suitable not only for private use, but also for use in the commercial and industrial sector (e.g. UC 42, Premium Collection).

The click connection makes laying the floor easier and guarantees good surface properties. In addition to the visually accomplished planks, wide planks and tiles of the Basic and Standard Collection, the Premium Collection in particular provides a highlight with its decors, which are available both as wide plank and in Herringbone format.

But CHECK is not only impressive in terms of functionality and design, but also with regard to healthy living. The carrier boards from CHECK one are mineral-based and therefore plasticizer-free. All round health benefits from the clever flooring.

STRUCTURE SPC CLICK VINYL FLOOR

UV-coating with wear layer

Design layer

SPC-carrier board

integrated underlay (for selected decors)

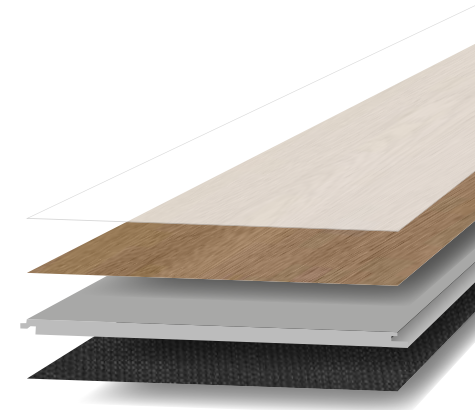

* according to manufacturer's approval

CHECK one | BASIC COLLECTION

PLANK INCL. INTEGRATED UNDERLAY

The vinyl planks of the *Basic Collection* are the ideal floor covering for renovations and refurbishments. In addition to their low structural height, they combine the elastic and water-resistant properties of a vinyl floor. The integrated impact sound insulation also facilitates installation and reduces walking noise.



DIMENSIONS: 1220 x 180 mm
THICKNESS: 4.5 mm



2430 Varrel Oak

Skirting: 2002-L | Accessories colour: Grey



18 dB
impact sound
reduction

2431 Büren Oak

Skirting: 2418-L | Accessories colour: Walnut

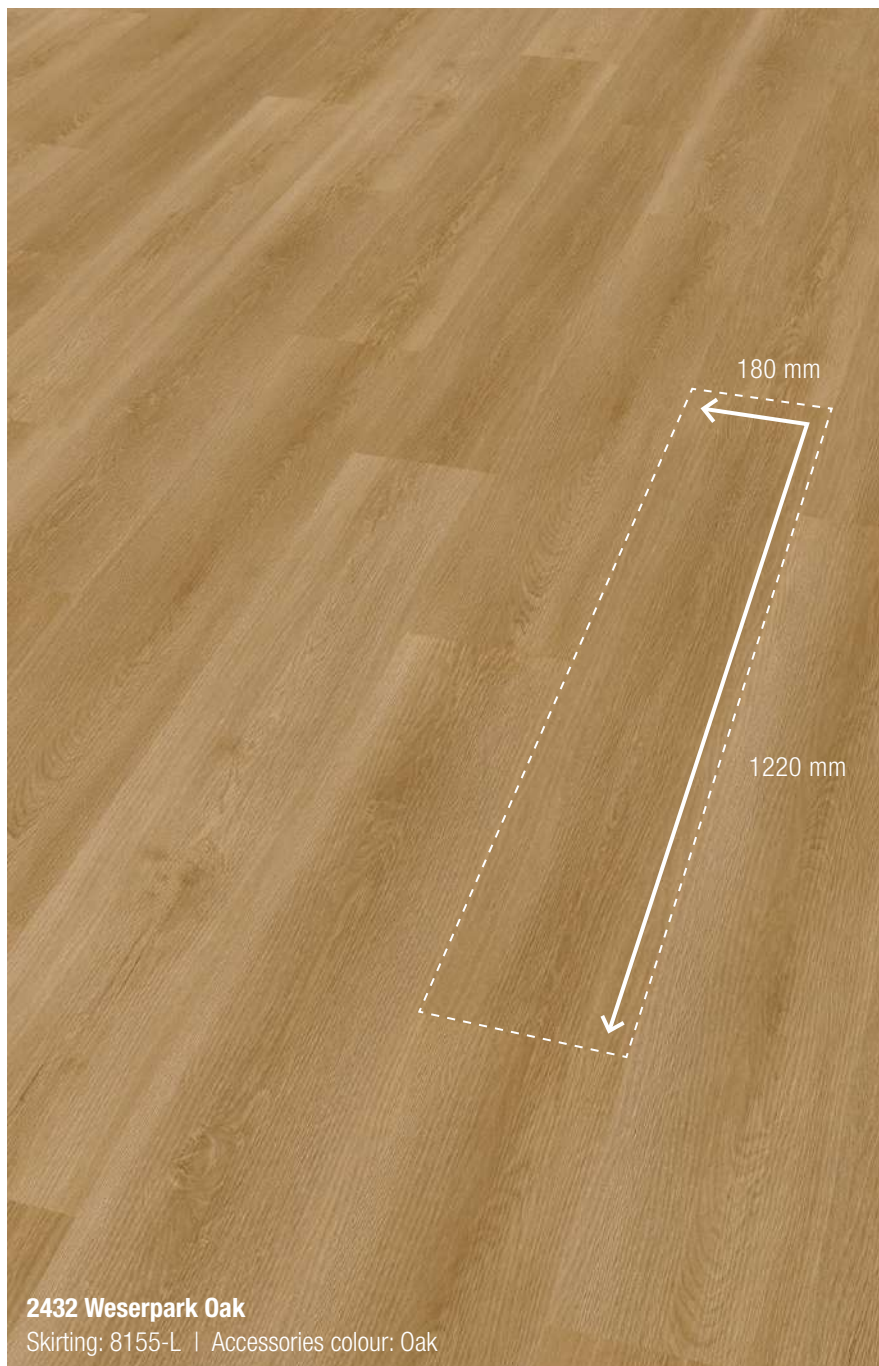



2451 Heek Oak

Skirting: 8058-L
Accessories colour: Silver grey



2452 Groden Oak

Skirting: 2002-L
Accessories colour: Silver grey



**UC
32**

DIMENSIONS: 1220 x 228 mm
THICKNESS: 4.5 mm

CHECK one | BASIC COLLECTION
WIDE PLANK INCL. INTEGRATED UNDERLAY

The wide planks of the *Basic Collection* ensure a generous spatial effect and are ideally suited for self-directed renovations. The low installation

height of the floor together with the integrated impact sound underlay makes installation easier and ensures a quiet room climate.



2453 Wildau Oak

Skirting: 2416-L | Accessories colour: Grey



2455 Felizitas Oak

Skirting: 2455-L | Accessories colour: Walnut

19 dB
impact sound
reduction

2454 Marga Oak

Skirting: 8155-L | Accessories colour: Oak



**NEW
2024**

2456 Kindl Oak



**NEW
2024**

2459 Brocker Feld Oak



**NEW
2024**

2460 Griesheim Oak



**NEW
2024**

2461 Buchrasen Oak



**NEW
2024**

2462 Horstmar Oak

CHECK one | STANDARD COLLECTION PLANK

The vinyl floors of the *Standard Collection* are available as CHECK one for clicking and mostly as CHECK expert for gluing. Both variants are robust and allow heavy com-

mercial use (utilisation class 33). They are equipped with a 4-sided bevel, which gives the plank a natural look.



DIMENSIONS: 1220 x 180 mm
THICKNESS: 4.0 mm

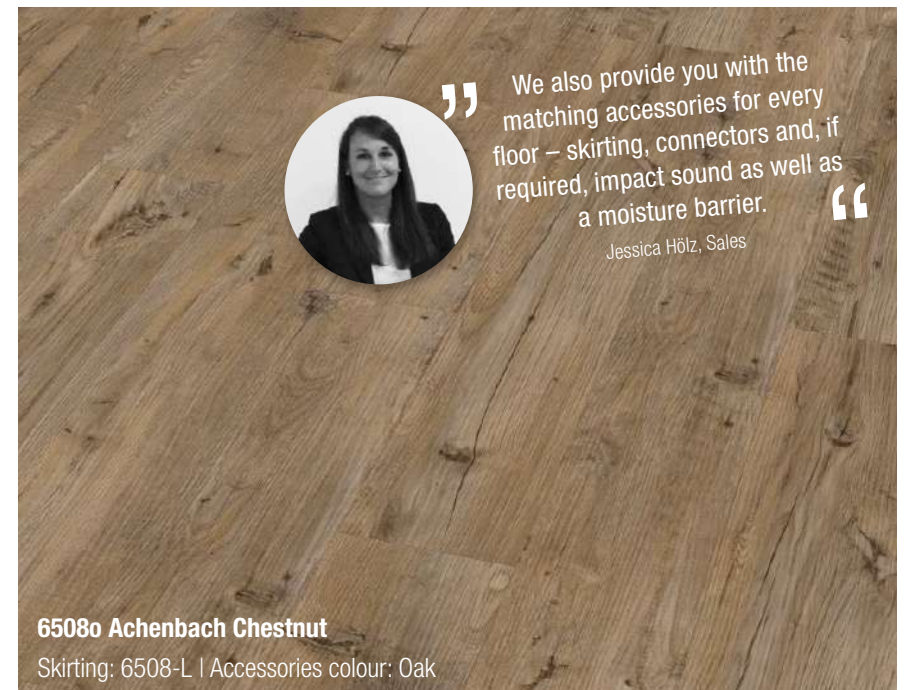
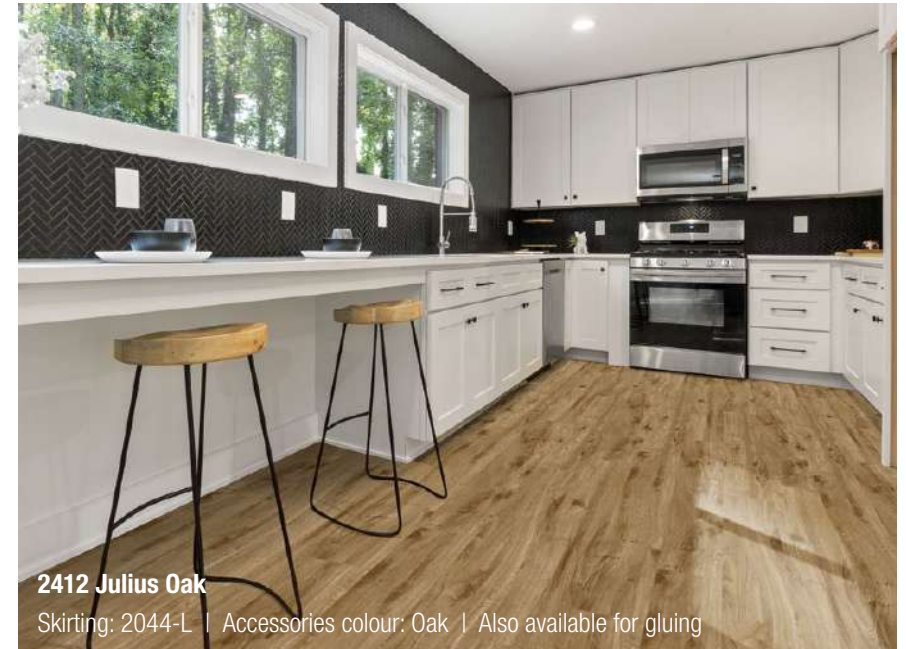
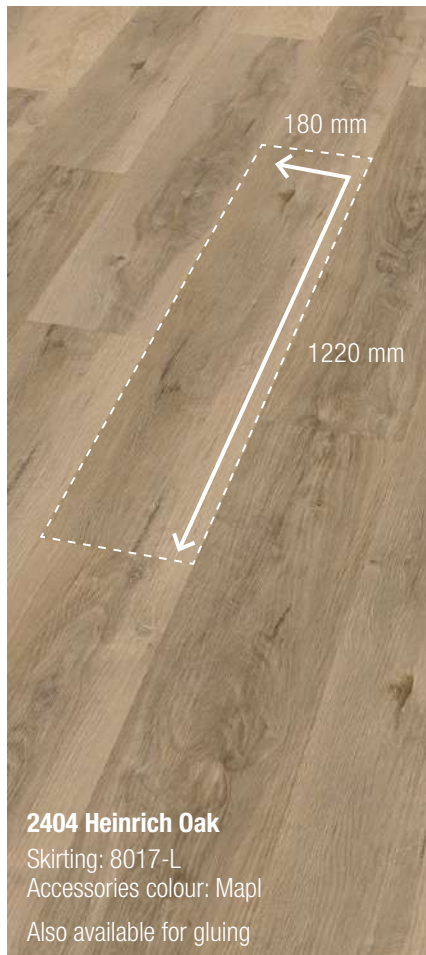

CHECK one | STANDARD COLLECTION

PLANK INCL. INTEGRATED UNDERLAY

The vinyl planks of the *Standard Collection* are also available with integrated impact sound insulation, which makes the floor particularly quiet and comfortable to walk

on. In addition, they are extremely easy to clean and hard-wearing. The four-sided all-round bevel ensures a natural appearance.



DIMENSIONS: 1220 x 182 mm
THICKNESS: 5.0 mm



2466 Wickrath Oak

Skirting: 2051-L
Accessories colour: Grey



OUR TIP:
**First look at
your furniture,
what suits me
and my
furnishings?**



”

Whether you just want to spruce something up quickly or get the whole flat a new floor - there's something for everyone here.

“

Anne Kandel,
Business Development Management

2467 Lohe Oak

Skirting: 8155-L
Accessories colour: Oak

CHECK one | STANDARD COLLECTION

WIDE PLANK

The CHECK one wide planks of the *Standard Collection* are convincing due to their format. In addition, the decor and the matt, authentic surface of the vinyl are shown to their best advantage on the wide planks and make the floor look even more natural. The all-round,

lacquered 4V groove additionally emphasises each individual plank and visually enlarges the space. Thanks to the simple and stable click system as well as a utilisation class of 34, the floor is prepared for any everyday situation.



DIMENSIONS: 1220 x 229 mm
THICKNESS: 4.0 mm



OUR TIP:
The ideal floor for pet owners, as the CHECK vinyl and design floors are easy to clean and hard-wearing.

2418 Freiberg Oak

Skirting: 2418-L

Accessories colour: Oak

2416 Caroline Oak

Skirting: 2416-L

Accessories colour: Grey





CHECK one | STANDARD COLLECTION

WIDE PLANK INCL. INTEGRATED UNDERLAY

Wide planks of the *Standard Collection* are also available with integrated impact sound insulation. The integrated underlay mat improves room acoustics and walking comfort. The special dimension looks par-

ticularly chic and inviting. In addition, the decor and surface are shown off to their best advantage thanks to the structure. The high-quality look is rounded off by a circumferential 4V groove.

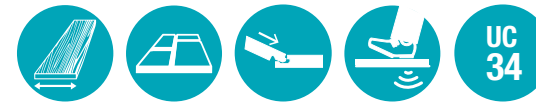

UC
34

DIMENSIONS: 1220 x 228 mm
THICKNESS: 5.0 mm



**2472 Morbach Oak**

Skirting: 8155-L | Accessories colour: Oak

**2474 Wullen Oak**

Skirting: 2058-L | Accessories colour: Beech

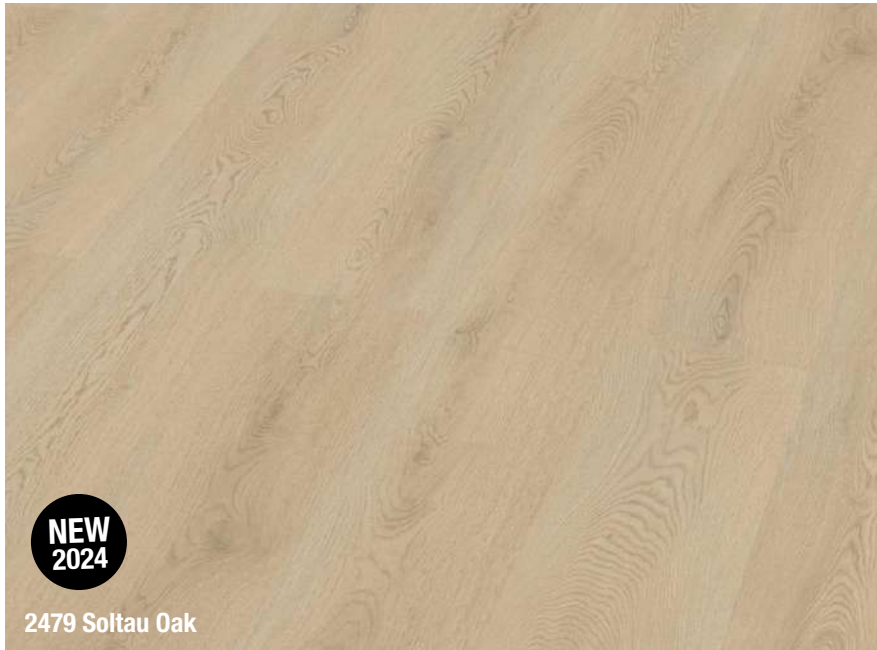

CHECK one | STANDARD COLLECTION | LONG- AND WIDE PLANKS INCL. INTEGRATED UNDERLAY

The new long and wide planks in the *Standard Collection* give every room an elegant and stylish look thanks to their dimensions. Combined with integrated impact sound and

a service class of 34 (heavy commercial use), the floor combines elegance, durability and fulfils every requirement.



DIMENSION: 1524 x 228 mm | **THICKNESS:** 6.5 mm

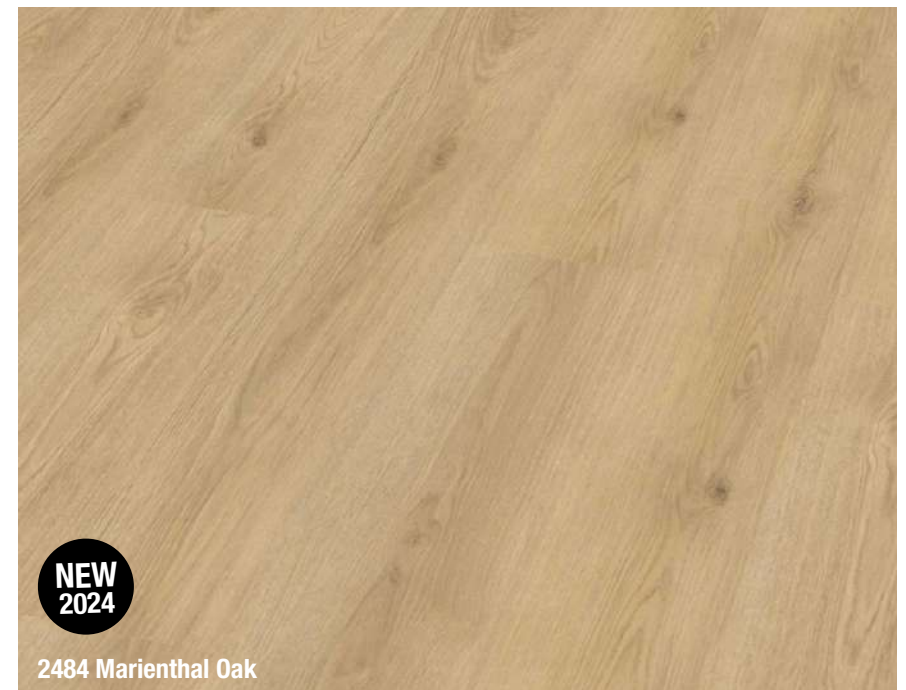
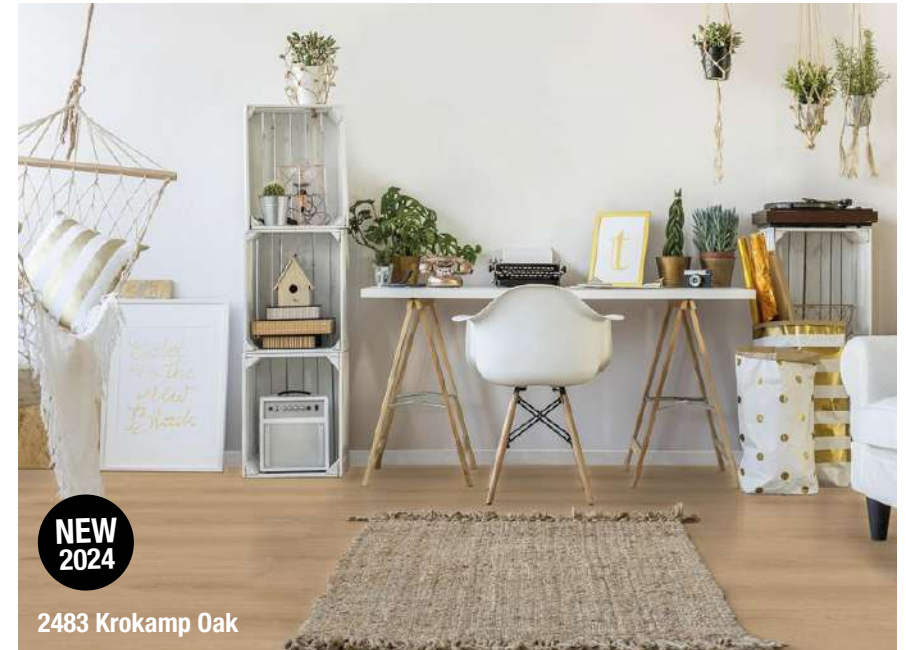
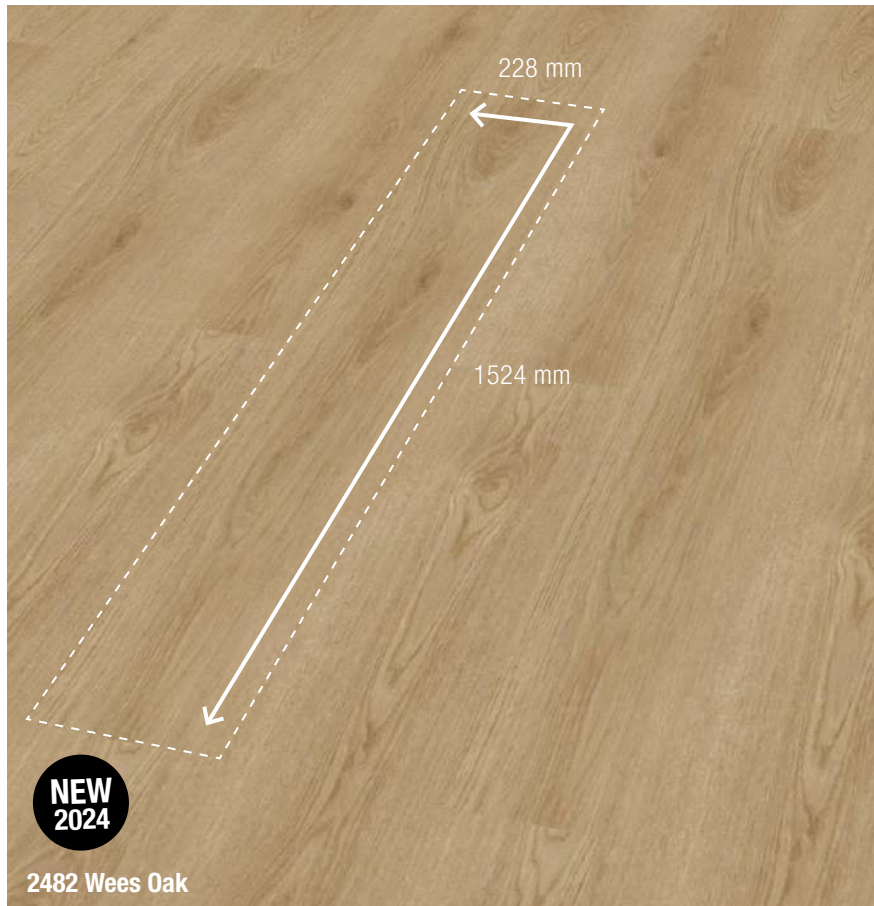



**NEW
2024**

2485 Grasholz Oak



**NEW
2024**

2486 Friedrichsort Oak



**NEW
2024**

2487 Weddingstedt Oak



**NEW
2024**

2488 Wesselhorn Oak

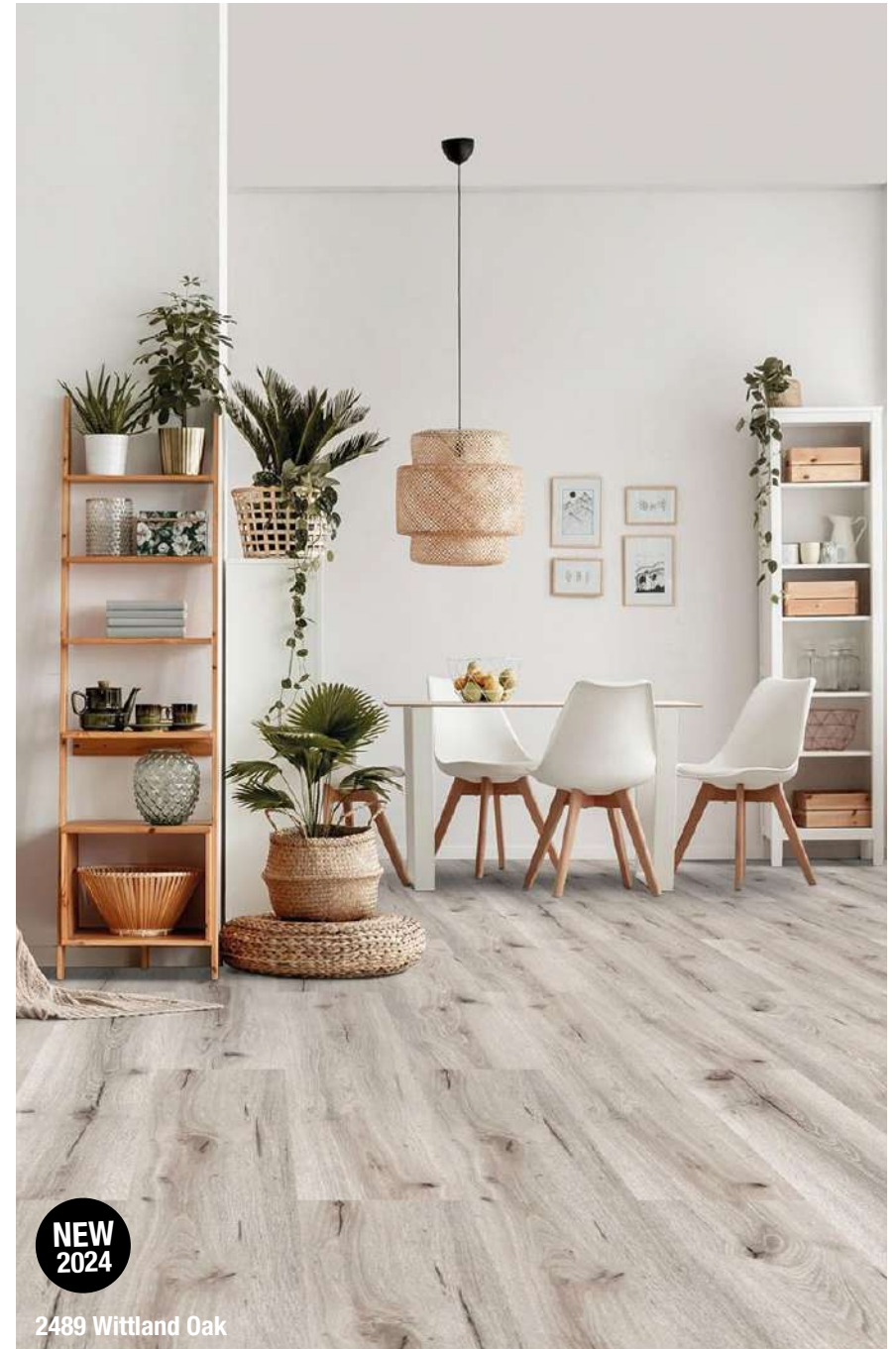

**NEW
2024**

2489 Wittland Oak

CHECK one | STANDARD COLLECTION TILE

For a long time, tiles in bathrooms and kitchens were the standard. But with vinyl floors, new possibilities arise. In contrast to ceramic tiles, vinyl is not only more cost-effective, but also easier on the joints, warmer on the feet and is suitable for laying on hot water under-

floor heating. The vinyl tiles with an authentic concrete and travertine design as well as a surrounding, real 4V groove, fit perfectly into all living rooms and bedrooms and are also suitable for the kitchen and bathroom.



DIMENSION: 610 x 305 mm
THICKNESS: 4.0 mm

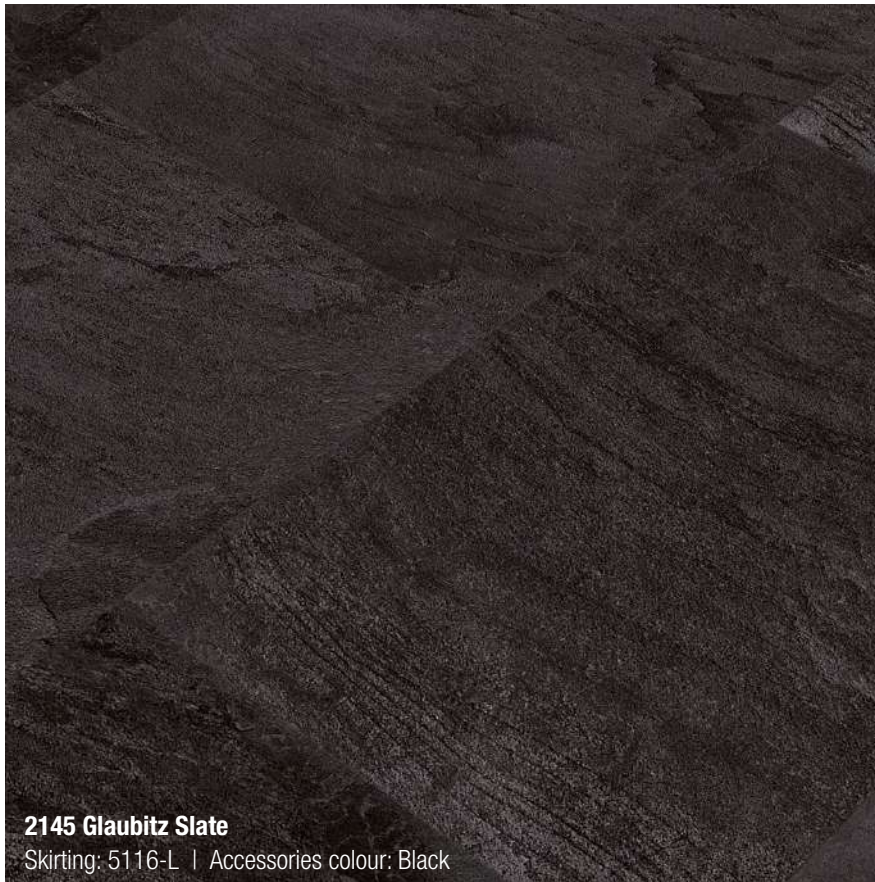

2145 Glaubitz Slate

Skirting: 5116-L | Accessories colour: Black

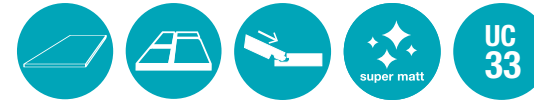

DIMENSION: 620 x 310 mm
THICKNESS: 4.0 mm



“ Our customers can rely on receiving their goods within three working days of ordering. ”
Kathrin Alfs, Administration

2144 Rinkam Marble

Skirting: 2143-L | Accessories colour: Grey



19 dB
impact sound
reduction

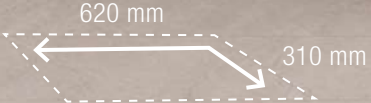

2140 Berne Botticino
Skirting: 2140-L | Accessories colour: Grey

CHECK one | STANDARD COLLECTION
TILE INCL. INTEGRATED UNDERLAY

The click vinyl tiles are also available with practical impact sound underlay. The floors are available in 620 x 310 mm format and impress with a super matt finish and deceptively real stone look. The surface is very hard-wearing

and can withstand everyday wear and tear. The all-round 4V groove emphasises the character of each individual tile. Thanks to the integrated impact sound underlay, walking noise is additionally reduced.



DIMENSIONS: 620 x 310 mm | **THICKNESS:** 5.0 mm



2141 Grillo Botticino
Skirting: 2141-L | Accessories colour: Silver grey



2142 Alma Marble
Skirting: 2869-L | Accessories colour: Black



2143 Agora Marble
Skirting: 2143-L | Accessories colour: Grey

CHECK one | STANDARD COLLECTION

XL-TILE INCL. INTEGRATED UNDERLAY

The XL format vinyl tiles are available with integrated impact sound underlay. The tiles impress with the super matt finish and real stone look as well as real 4V groove. This means they fit perfectly into everyone

spatiality. With a usage class of 33 they are ideal for people who are under heavy strain rooms in residential and commercial areas.



DIMENSIONS: 830 x 470 mm | **THICKNESS:** 5.0 mm



OUR TIP:
Make sure that you use
floors in the bathroom
and kitchen that are
suitable for wet rooms.

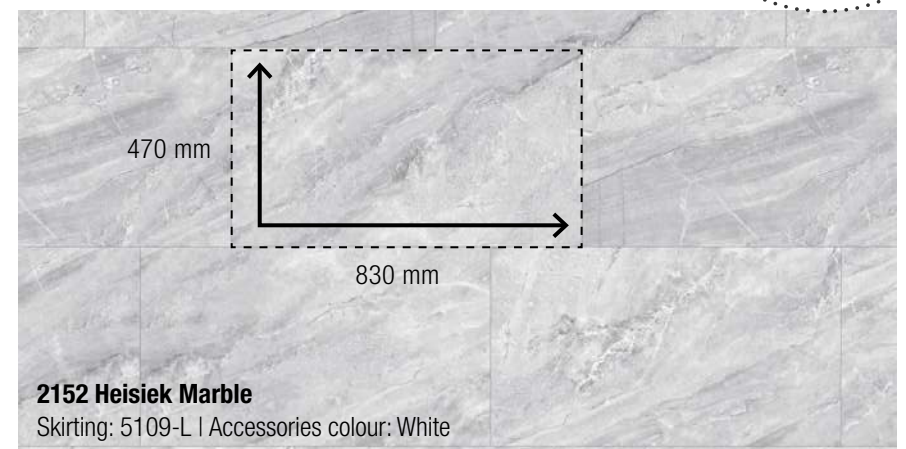





2157 Alsberg Marble

Skirting: 2143-L

Accessoires colour: White

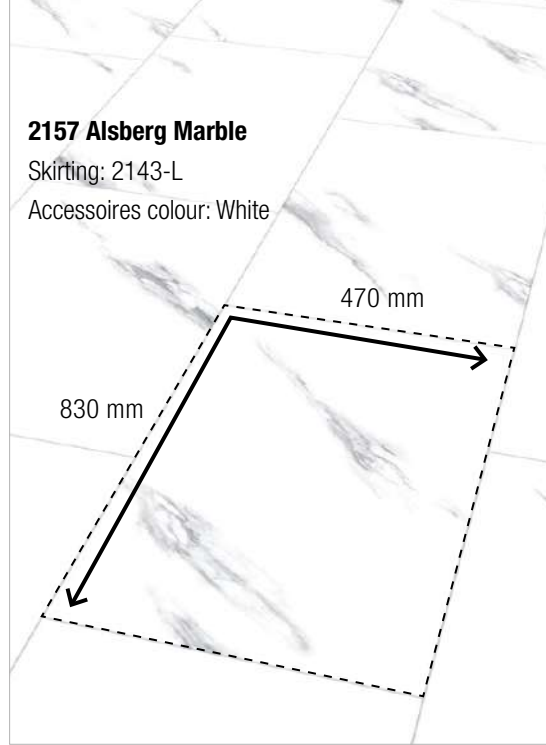

2158 Kapellen Marble

Skirting: 5115-L

Accessoires colour: Grey



2156 Pulheim Marble

Skirting: 2869-L

Accessoires colour: Black

19 dB
impact sound
reduction

CHECK one | STANDARD COLLECTION
XL-TILE INCL. INTEGRATED UNDERLAY

The vinyl tiles in XL format are also available in high gloss with an integrated impact sound underlay and a real 4V groove that empha-

sizes the character of each individual tile. This means they fit perfectly into everyone spatiality.



DIMENSIONS: 830 x 470 mm | **THICKNESS:** 5 mm



2159 Levin Marble

Skirting: 3079-L | Accessoires colour: Black



2160 Glehner Marble

Skirting: 5109-L | Accessoires colour: White



CHECK one | PREMIUM COLLECTION
WIDE PLANK

A floor has to endure a lot, that's why it should be as durable as possible and meet a wide range of demands. The vinyl planks in wide plank format are therefore available

as CHECK one and CHECK expert in the *Premium Collection* and are suitable for medium industrial use. Visually, the wide planks impress with their 4-sided bevel.



DIMENSIONS: 1220 x 227 mm
THICKNESS: 4.0 mm

DECORS ALSO AVAILABLE AS CHECK expert IN THE PREMIUM COLLECTION! SEE PG. 78-81



2045 Hellweg Oak

Skirting: 2045-L | Accessories colour: Maple | Also available for gluing

MIX



2044 Victoria Oak

Skirting: 2044-L | Accessories colour: Oak | Also available for gluing



2047 Vondern Oak

Skirting: 8024-L
 Accessories colour: Silver grey
 Also available for gluing



2049 Bonifacius Oak

Skirting: 2003-L
 Accessories colour: Grey
 Also available for gluing

227 mm

1220 mm



2048 Anna Oak

Skirting: 2002-L | Accessories colour: Silver grey | Also available for gluing

**CHECK one | PREMIUM COLLECTION | WIDE PLANK
INCL. INTEGRATED UNDERLAY**

Vinyl floors in wide plank format are also available in the *Premium Collection* with integrated impact sound underlay. The floors are particularly quiet with an impact sound reduction of 21 dB, so that no further insulation underlay is required. The matt and

extremely authentic design, combined with the textured surface, not only offers a great look, but also a realistic feel, which makes the floor the main focus of every room. In addition, all wide planks are also available as an identical decor in Herringbone format.



DIMENSIONS: 1220 x 229 mm
THICKNESS: 5.0 mm



21 dB
Impact sound reduction

2072 Altano Oak
Skirting: 8155-L
Accessories colour: Oak



2074 Prenzlau Oak
Skirting: 2045-L
Accessories colour: Maple



2073 Lausitz Oak
Skirting: 2073-L
Accessories colour: Silver grey



2075 Fläming oak
Skirting: 2075-L
Accessories colour: Silver grey

2076 Boxbach Oak

Skirting: 3522-L

Accessories colour: Walnut

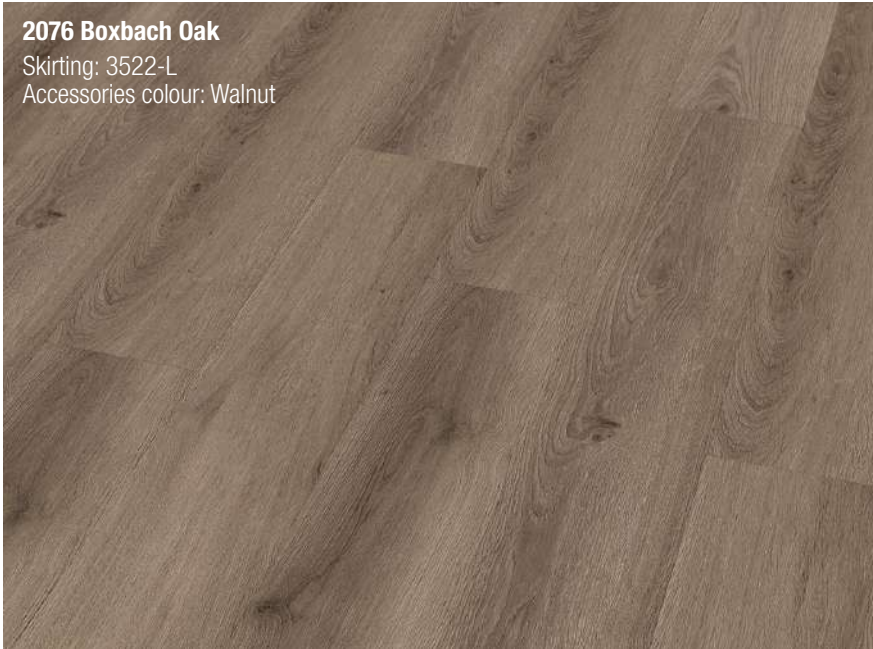
**2077 Altenwald Oak**

Skirting: 8221-L

Accessories colour: Oak

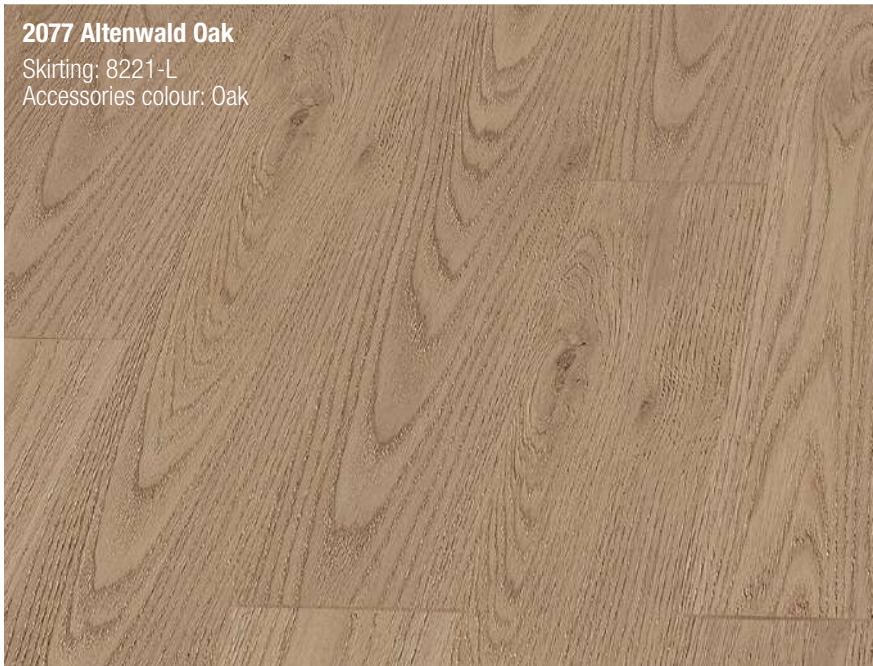
**2078 Burbach Oak**

Skirting: 2519-L

Accessories colour: Oak

CHECK one | PREMIUM COLLECTION | HERRINGBONE
INCL. INTEGRATED UNDERLAY

The matt, authentic decors in wide plank format with natural bevel are also available as herringbone with integrated impact sound. The herringbone format, which dates back to 1900, proves to be a timeless classic due to its elegance. Because of the different arrangement of the planks, there are numerous

possibilities to design the room according to your own ideas. Smaller rooms can thus be optically enlarged, depending on the installation pattern. In rooms with plenty of daylight, the herringbone look radiates additional energy and harmony.



DIMENSIONS: 592 x 148 mm
THICKNESS: 5.5 mm

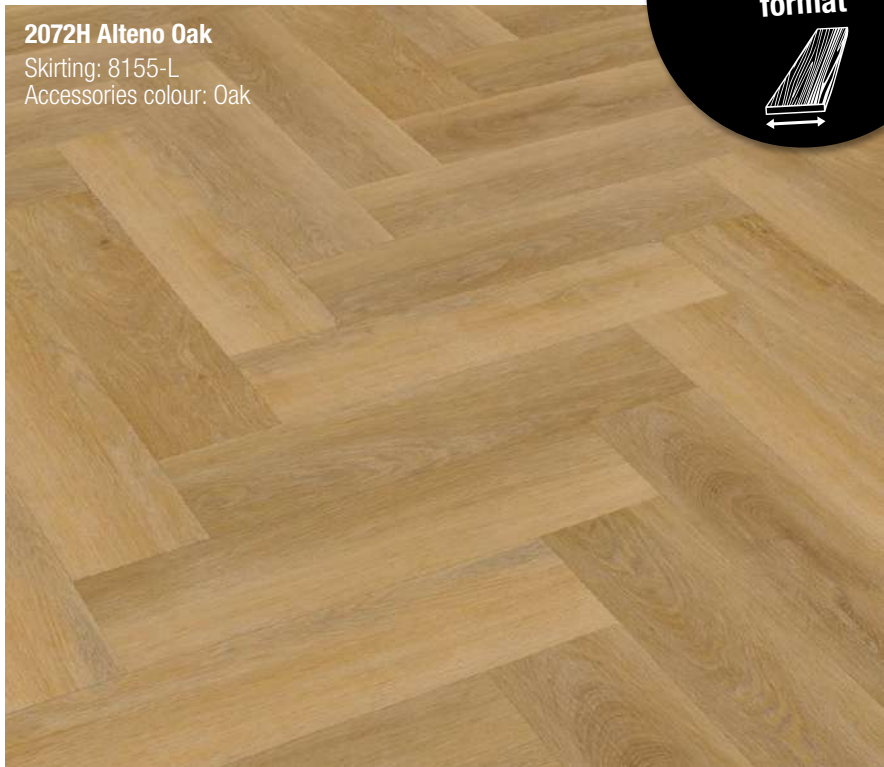

2072H Alteno Oak
 Skirting: 8155-L
 Accessories colour: Oak



2073H Lausitz Oak
 Skirting: 2073-L | Accessories colour: Silver grey



2074H Prenzlau Oak
 Skirting: 2045-L | Accessories colour: Maple



2075H Fläming Oak
 Skirting: 2075-L | Accessories colour: Silver grey



2076H Boxbach Oak

Skirting: 3522-L | Accessories colour: Walnut

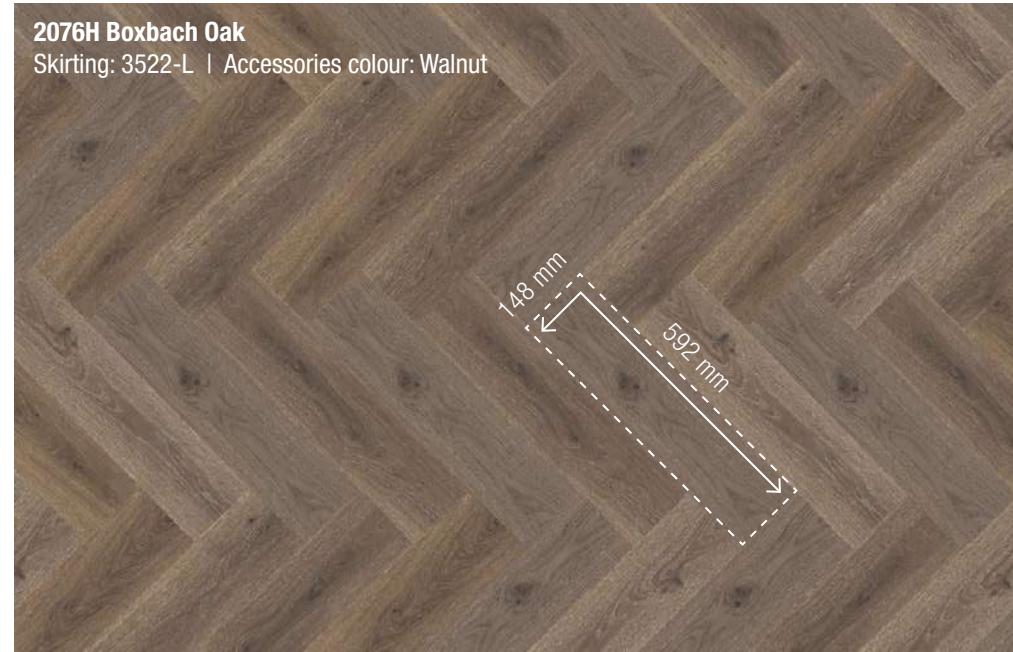

2078H Burbach Oak

Skirting: 2519-L | Accessories colour: Oak

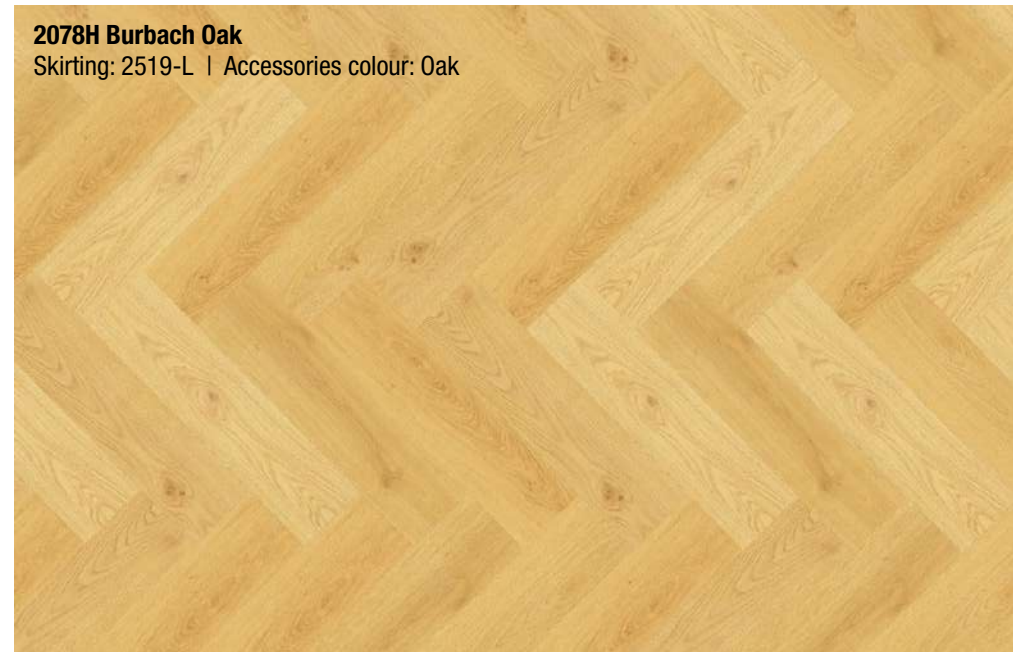

” With the timeless herringbone pattern, you have a decor that will be trendy throughout the product's lifetime. “
Katharina Gorski, Product Management

2077H Altenwald Oak

Skirting: 8221-L | Accessories colour: Oak

CHECK one PREMIUM COLLECTION | WIDE PLANK SYNCHRONOUS INCL. INTEGRATED UNDERLAY

The *Premium Collection* offers vinyl flooring in a generous wide plank format, which is particularly quiet thanks to integrated foot-fall sound insulation, meaning that no additional insulation is required. The synchronised embossing of the surface makes the floor

look particularly authentic and impresses with a realistic feel that perfectly matches the look. With a service class of 42, this floor is also suitable for industrial use, making it a stylish and robust eye-catcher in any room.



DIMENSION: 1220 x 229 mm
THICKNESS: 5.0 mm



2490 Weitenhagen Oak



2491 Ziegelhof Oak



2492 Mühlendorf Oak



**NEW
2024**

2490H Weitenhagen Oak

CHECK one **PREMIUM COLLECTION** | **HERRINGBONE** **SYNCHRONOUS INCL. INTEGRATED UNDERLAY**

Vinyl flooring in the elegant Herringbone design is also available in the *Premium Collection* in wide plank format with integrated footfall sound insulation. Thanks to impact sound reduction, these floors are particularly quiet, meaning that no additional insula-

ting underlay is required. The extremely authentic Herringbone pattern in combination with the textured surface not only offers an appealing look, but also a realistic feel that makes the floor an eye-catcher in any room.

All decors also available in **wide plank format**





DIMENSION: 592 x 148 mm | **THICKNESS:** 5.5 mm

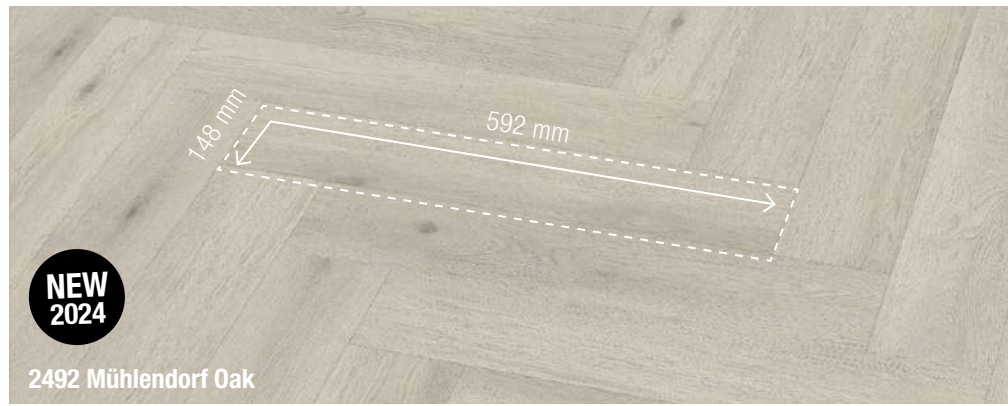

**NEW
2024**

2491H Ziegelhof Oak



**NEW
2024**

2492 Mühlendorf Oak



All decors
also available in
Herringbone
format

NEW
2024

2475 Deisenfang Oak

**CHECK one | PREMIUM COLLECTION | WIDE AND LONG PLANKS
INCL. INTEGRATED UNDERLAY**

Vinyl flooring in a generous wide and long plank format is available in the *Premium Collection* with integrated footfall sound insulation. The authentic design of the wide and long planks, combined with a joint pattern with a 4-sided bevel, not only offers an appealing

look, but also a realistic feel that makes the floor a highlight in any room. With integrated impact sound and a service class of 42, the floor is also suitable for industrial use and impresses with its robust load-bearing capacity.



DIMENSION: 1524 x 228 mm | **THICKNESS:** 5.5 mm



NEW
2024

2476 Kammerbrühl Oak



NEW
2024

2477 Baienbach Oak



NEW
2024

2478 Buchäcker Oak



All decors also available in wide plank format

NEW
2024

2475H Deisenfang Oak

CHECK one | PREMIUM COLLECTION
HERRINGBONE INCL. INTEGRATED UNDERLAY

The Premium Collection offers stylish vinyl floors in the classic Herringbone pattern, which impress with their detailed design and high quality. With a 4-sided bevelled edge, the joint pattern creates a particularly elegant look that gives the floor a natural and high-quality appearance. Thanks to the

realistic structure, the floor also has an authentic feel, making it an eye-catcher in any room. With a service class of 42, the floor is also extremely hard-wearing and is ideal for industrial use where high load-bearing capacity is required.



DIMENSION: 750 x 150 mm | **THICKNESS:** 5.5 mm

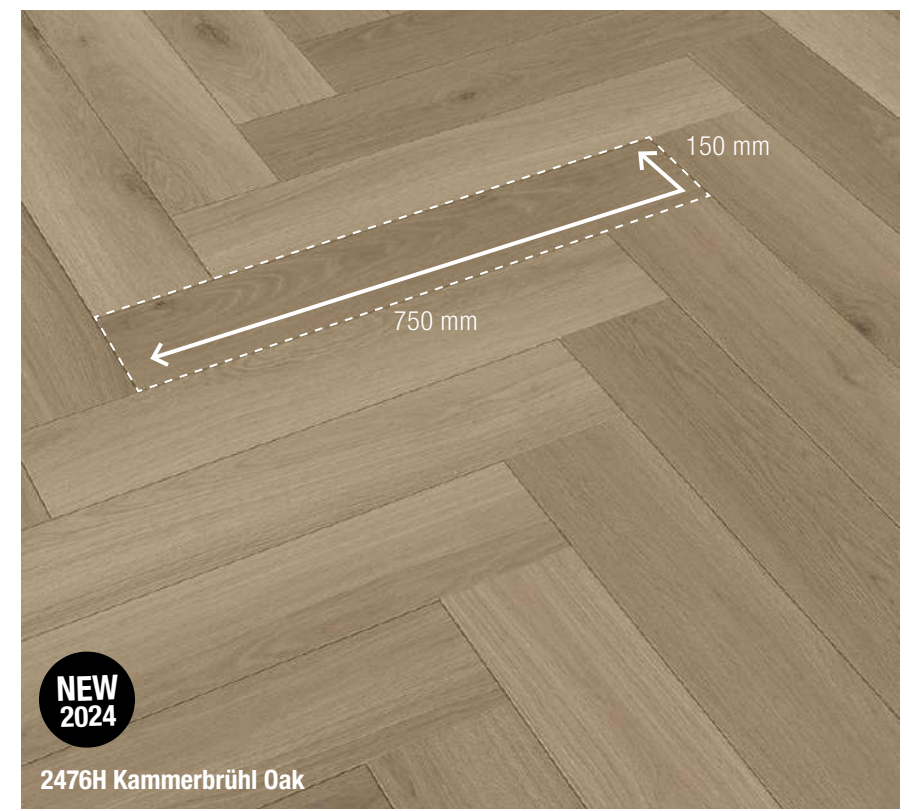

NEW
2024

2476H Kammerbrühl Oak



CHECK

expert

Some decors of the CHECK one as well as the CHECK comfort series are also available for gluing. The phthalate-free Dryback floors from CHECK expert have the advantage that they are even more hard-wearing and resilient than a floating floor covering due to the full-surface glue-down installation. Thus, it is particularly suitable for heavily frequented or stressed areas. The floors are dimensionally stable and do not move. In the commercial sector, fixed adhesion is sometimes mandatory, and therefore CHECK expert is the perfect choice.

Adhesive bonding is also useful with regard to footfall and walking noise. The covering and the subfloor form a solid unit, which leads to a reduction in walking noise. CHECK expert is also suitable for underfloor heating, as the heat is conducted particularly well from the subfloor to the surface due to the full-surface bond.*

CHECK expert – the long-lasting option from the specialist, lasting enjoyment of a healthy living floor.



STRUCTURE DRYBACK VINYL FLOOR

- UV-coating with wear layer
- Design layer
- Middle layer of virgin vinyl
- Virgin vinyl balance layer

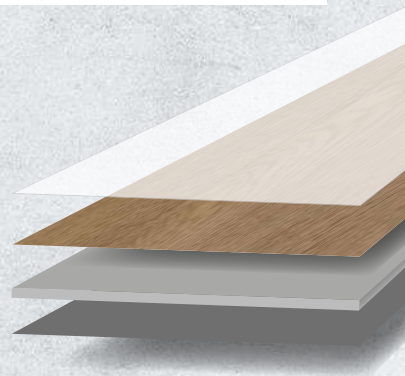

**15 YEAR
GUARANTEE**
according to guarantee conditions



· suitable for floor-to-ceiling windows and residential conservatories *



· suitable for damp rooms *



· easy to clean



· extremely hard-wearing



· warm underfoot



· very low construction height



· suitable for hot water underfloor heating *



· phthalate-free

CHECK expert | STANDARD COLLECTION PLANK

The CHECK expert vinyl planks of the *Standard Collection* are sound-absorbing, heat-insulating and easy to maintain. With a utilisation class of 33, they are robust and resistant.



DIMENSIONS: 1227 x 187 mm
THICKNESS: 2.0 mm



OUR TIP:
Be sure to follow the recommendations of the adhesive manufacturer so that the vinyl adheres permanently to the subfloor without becoming detached.

2405E Theodor Oak

Skirting: 2051-L
Accessories colour: Grey



2404E Heinrich Oak

Skirting: 8017-L
Accessories colour: Maple

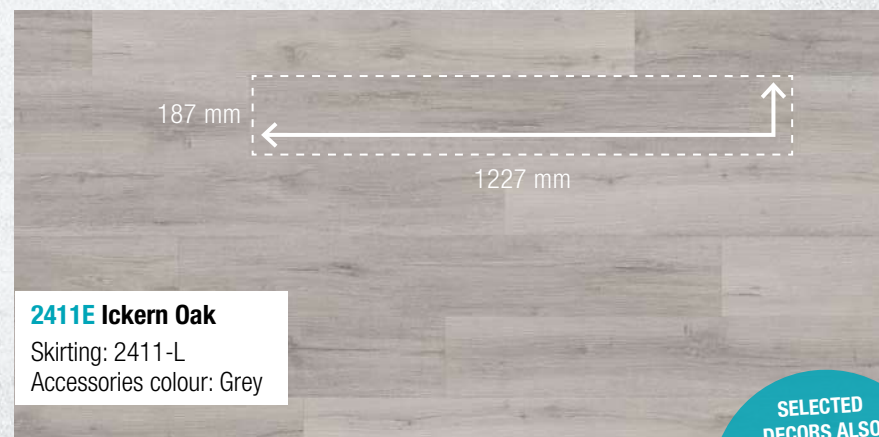

2411E Ickern Oak

Skirting: 2411-L
Accessories colour: Grey

SELECTED
DECORS ALSO
AVAILABLE AS
CHECK one IN
THE STANDARD
COLLECTION!
SEE PG. 22-23

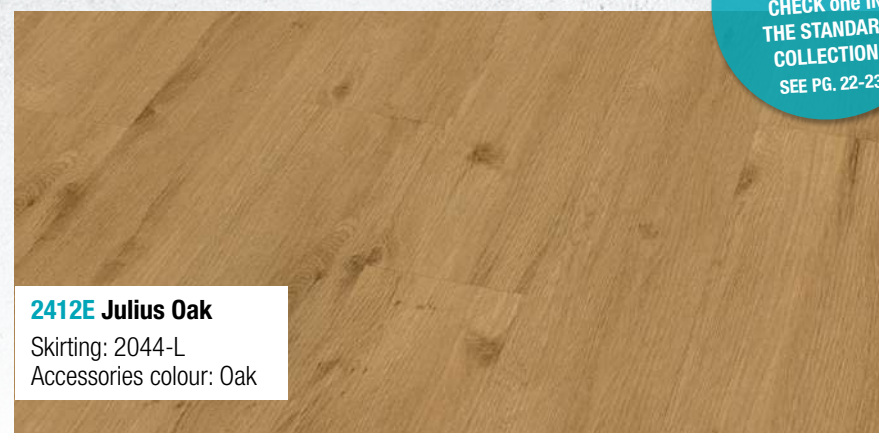

2412E Julius Oak

Skirting: 2044-L
Accessories colour: Oak

CHECK expert | PREMIUM COLLECTION WIDE PLANK

The wide planks of the *Premium Collection* impress with their high durability and are therefore ideally suited for heavily used rooms. The

wide plank format in combination with the 4-sided bevel makes for a special eye-catcher in any room.



DIMENSIONS: 1219 x 229 mm
THICKNESS: 2.5 mm

DECORS ALSO
AVAILABLE AS
CHECK one IN
THE PREMIUM
COLLECTION!
SEE PG. 52-55



2044E Victoria Oak

Skirting: 2044-L
Accessories colour: Oak



2045E Hellweg Oak

Skirting: 2045-L
Accessories colour: Maple



2047E Vondern Oak
Skirting: 8024-L
Accessories colour: Silver grey



2048E Anna Oak
Skirting: 2002-L
Accessories colour: Silver grey



2049E Bonifacius Oak
Skirting: 2003-L
Accessories colour: Grey

CHECK expert | PREMIUM COLLECTION WIDE AND LONG PLANK

The extravagant format of the wide and long planks of the *Premium Collection*, give rooms depth and makes them appear larger. The exceptional format is further emphasised by

the all-round bevel. However, the planks are not only visually appealing, but also robust and can also be used in the commercial sector due to their high utilisation class.



UC
42

DIMENSIONS: 1520 x 238 mm
THICKNESS: 2.5 mm

DECORS ALSO
AVAILABLE AS
CHECK comfort
DECORS!
SEE PG. 96-99



2509E Tordera Oak

Skirting: 2509-L
Accessories colour: Maple



2511E Albera Oak

Skirting: 2511-L
Accessories colour: Oak



“ Our floors can withstand the highest levels of stress. Because with a little care, they are our companion for a lifetime. ”

Dennis Franz, Office Staff

2510E Benavente Oak

Skirting: 2510-L
Accessories colour: Oak



2512E Gavarres Oak
 Skirting: 2512-L
 Accessories colour: Maple



2513E Montnegre Oak
 Skirting: 2513-L
 Accessories colour: Maple



2514E Breda Oak
 Skirting: 2514-L
 Accessories colour: Grey

CHECK expert | PREMIUM COLLECTION XL-TILE

The XL vinyl tiles are ideal in strong stressed living areas up to areas with industrial use (usage class 42). They are visually convin-

cing with their realistic stone look with all-round chamfer.



DIMENSIONS: 914.40 x 457.20 mm
THICKNESS: 2.5 mm

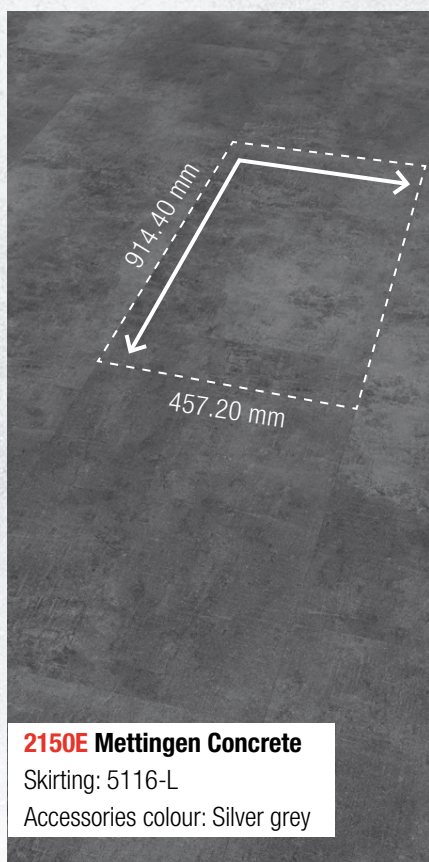

2150E Mettingen Concrete

Skirting: 5116-L

Accessories colour: Silver grey



2153E Rhadener Concrete

Skirting: 3512-L

Accessories colour: Grey



2154E Marbach Concrete

Skirting: 2124-L

Accessories colour: Grey

CHECK ✓

comfort

FOR YOUR WELLBEING.

18
comfort
STYLISH
DECORS



STYLISH. EXCLUSIVE. LONG-LASTING.

With **CHECK comfort** you get a floor to feel good, which is as powerful as it is stylish. An all-round exclusive product that delivers what it promises.

The SPC floors from the **CHECK comfort** range can withstand a lot. The hard core on a mineral basis achieves high stability and dimensional stability.

The ABA floors also offer the advantage that the stable SPC carrier board is enclosed by two LVT-layers. The ABA floors thus combine the advantages of a classic vinyl floor with those of an SPC floor – they are extremely robust and at the same time warm underfoot and therefore pleasant to walk on.

In addition, all **CHECK comfort** floors are equipped with an integrated, natural cork impact sound underlay, which reduces the walking noise and thus additionally ensures a soothing sense of space. In order to make the living space not only beautiful and comfortable, but also healthy, all collections have been awarded with the „TÜV PROFICERT product Interior Premium“ trademark and promise the highest quality.

With **CHECK comfort**, you get a floor that offers the same performance and feel-good factor as on the first day, even after years of use.

suitable for floor-to-ceiling windows and residential conservatories *



durable



floors incl. integrated cork impact sound underlay



easy to clean



warm underfoot



suitable for hot water underfloor heating *



quiet



**15 YEAR
GUARANTEE**
according to guarantee conditions

* according to manufacturer's approval

**BEST
POSSIBLE
IMPACT SOUND
REDUCTION**

**INCL.
INTEGRATED
CORC-
UNDERLAY**

STRUCTURE OF SPC CLICK VINYL FLOOR

- UV coating with wear layer
- Design layer
- SPC-carrier board
- Integrated cork underlay

AVAILABLE AS
Wide plank SPC
Long & wide plank SPC

STRUCTURE OF ABA CLICK VINYL FLOOR

- UV coating with wear layer
- Design layer
- LVT-layer
- SPC-carrier board
- LVT-layer
- Integrated cork underlay

AVAILABLE AS
Wide plank ABA
Long & wide plank ABA

comfort

Wide plank SPC
incl. integrated cork underlay

The robust SPC wide planks with a plank width of 225 mm give the impression of spaciousness. An all-round, elegant 4-sided beveled edge highlights and visually emphasises each individual plank in the overall picture. The super matt finish-surface makes the wood look even more authentic.



DIMENSIONS: 1220 x 225 mm
THICKNESS: 5.0 mm



2506 Silves Oak | Skirting 2506-L | Accessories colour: Maple

comfort _____ Wide plank SPC



2507 Agullana Oak | Skirting 2507-L | Accessories colour: Oak



2508 Eslida Oak | Skirting 2508-L | Accessories colour: Grey

comfort

Long & wide plank SPC
incl. integrated cork underlay

The SPC long and wide plank from CHECK comfort is shown off to it's best advantage in large rooms. The exclusive format combined with the deceptively real wood look gives your home an impressive, elegant character. The integrated cork insulation enhances the feeling of well-being by significantly reducing impact sound.



DIMENSIONS: 1522 x 225 mm
THICKNESS: 5.0 mm

DECORS ALSO AVAILABLE AS CHECK expert IN THE PREMIUM COLLECTION! SEE PG. 82-85

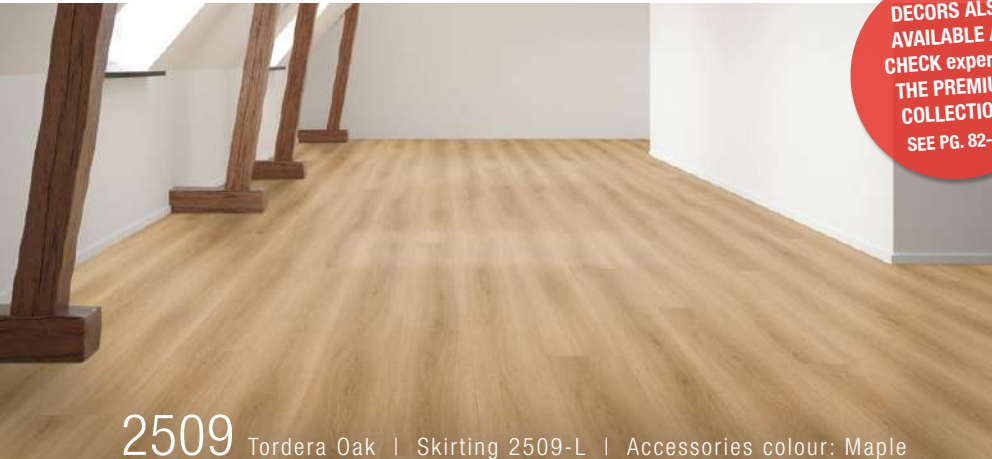

2509 Tordera Oak | Skirting 2509-L | Accessories colour: Maple



2510 Benavente Oak | Skirting 2510-L | Accessories colour: Oak

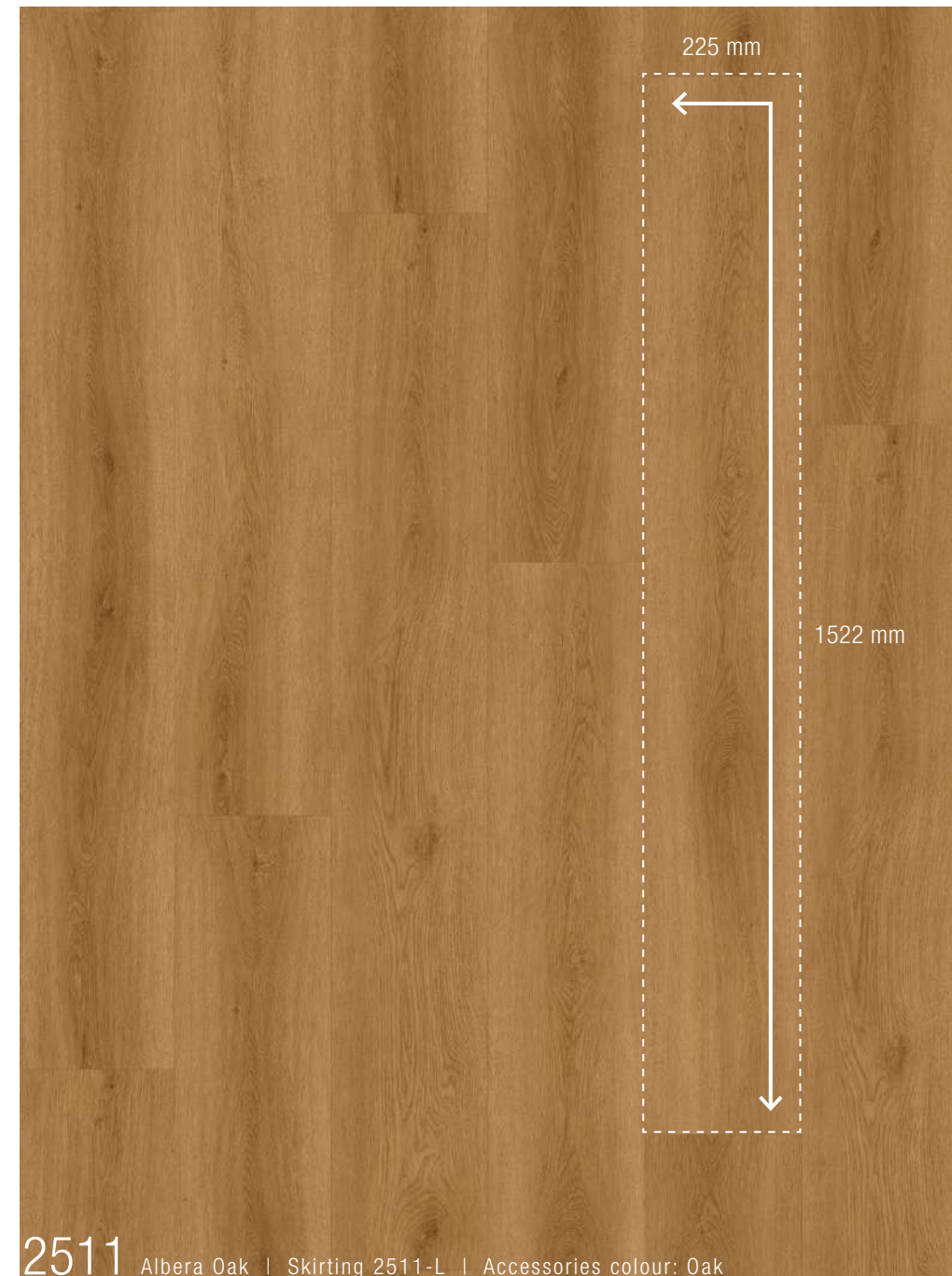

2511 Albera Oak | Skirting 2511-L | Accessories colour: Oak



” Our comfort floors are the ultimate in the entire CHECK range. They offer the greatest possible comfort and are visually a real eye-catcher. “

Sabrina Franzke, Sales

2512 Gavarres Oak | Skirting 2512-L | Accessories colour: Maple

2513 Montnegre Oak | Skirting 2513-L | Accessories colour: Maple

comfort _____ Long & wide plank SPC



2514 Breda Oak | Skirting 2514-L | Accessories colour: Grey

comfort

Wide plank ABA
incl. integrated cork underlay

The CHECK comfort wide planks are the perfect floor covering for quiet treads who place a lot of value on appearance and high quality. Due to their surface structure, the floors look particularly authentic, since they run synchronously with the wood grain and

thus create a deceptively real wood look. The product structure ensures increased stability and insensitivity to climatic fluctuations. The already integrated impact sound insulation made of cork gives the floor additional warmth and reduces impact sound.



UC
42

DIMENSIONS: 1220 x 229 mm
THICKNESS: 6.5 mm

2500 Boltenhof Oak | Skirting 6502-L | Accessories colour: Oak | *random

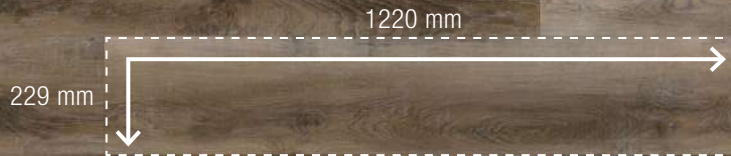

2503 Ladeburg Oak | Skirting 2503-L | Accessories colour: Silver grey

comfort

Wide plank ABA



2504 Kerz Oak | Skirting 2418-L | Accessories colour: Oak



2505 Rahden Oak | Skirting 2419-L | Accessories colour: Grey

comfort

Long & wide plank ABA
incl. integrated cork underlay

The ABA wide and long planks impress equally with their comfort as well as their elegant format and decor. The slightly beveled edges ensure a harmonious transition between the planks. The surface structure is both synchronously embossed as well as super matt and is in no way inferior to the real wood floor visually or haptically.

Thanks to the SPC carrier board and the two LVT-layers, the floor achieves the highest level of walking comfort, which also protects the joints. Paired with the integrated cork impact sound underlay, the floor has properties that even a real wood floor can not achieve.



DIMENSIONS: 1522 x 225 mm | **THICKNESS:** 5.5 mm



2515 Pedro Oak | Skirting 2515-L | Accessories colour: Silver grey



2516 Tajo Oak | Skirting 2516-L | Accessories colour: Oak



2517 Seva Oak | Skirting 2517-L | Accessories colour: Oak

OUR TIP:
If you have joint problems, an ABA floor can be considered, since its soft and flexible construction relieves the strain on the limbs.



EXCLUSIVE DECORS
FOR A STYLISH,
COMFORTABLE LIVING.

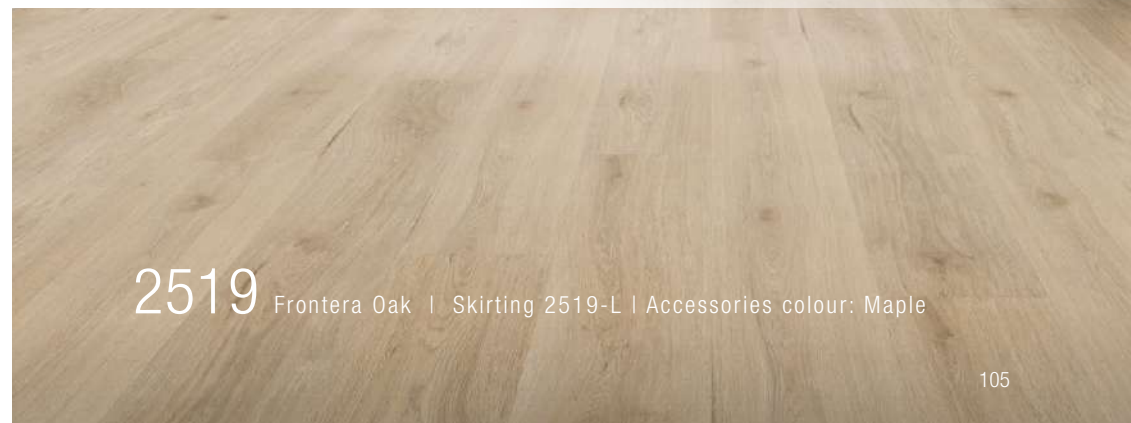

CHECK ✓
green

**15 YEAR
GUARANTEE**

according to guarantee conditions

**THE GREEN
DESIGN
FLOOR**

THE DESIGN FLOOR, THAT IS CONSIDERATE OF OUR HEALTH AND THE ENVIRONMENT.

CHECK green is completely PVC-, pollutant- and plasticizer-free and therefore harmless to our health. The French VOC regulation with the A+ label confirms the highest indoor air quality. The antibacterial surface also inhibits bacterial growth and provides additional protection.

Its climate-neutral production in Germany also protects the environment. This is also confirmed by the eco-INSTITUT environmental seal and the "Blue Angel".



www.blauer-engel.de/uz176



PVC-FREE



PLASTICIZERS-FREE



SUSTAINABLE



**MADE IN
GERMANY**

CHECK GREEN: A FLOOR THAT LOVES WATER.

CHECK green has an aqua-stop carrier board, which makes the floor more resistant to liquids without accepting damage.* The design floor can thus be installed in bathrooms, kitchens, hallways and other rooms.

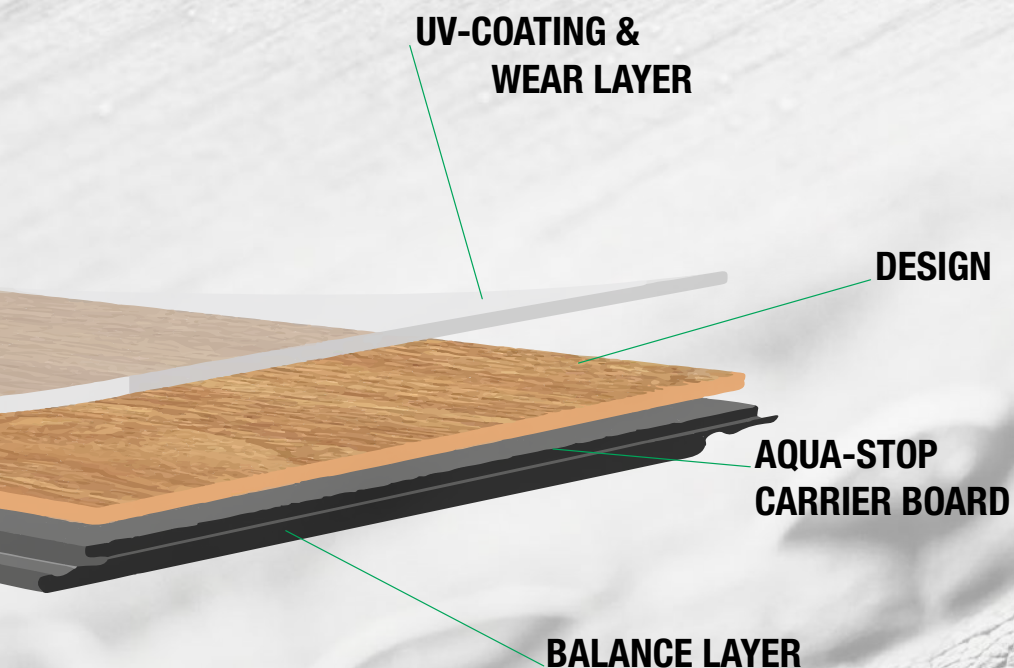

HEALTHY LIVING
WATER RESISTANT*
ROBUST
VERY HARD-WEARING
HEAT RESISTANT
LIGHTFAST
SUSTAINABLE
ANTIBACTERIAL
ANTISTATIC

* according to manufacturer's approval



GREEN COLLECTION PLANK

The CHECK green design floors are extremely functional and hard-wearing. Its attractive decor is additionally emphasized by the 4V-groove. With a construction height of 6 mm,

the product group is particularly renovation-friendly and with a utilisation class of 32, it is even suitable for commercial use.



DIMENSIONS: 1288 x 195 mm
THICKNESS: 6.0 mm

**UC
32**



2447 Eicks Oak
Skirting: 8147-L
Accessories colour: Grey



2448 Dreiborn Oak
Skirting: 2045-L
Accessories colour: Maple



“ Anyone who values sustainability and healthy living can install CHECK Green with a clear conscience. ”
Michel Kommnik, Office Staff



2449 Heimbach Oak
Skirting: 8013-L
Accessories colour: Grey



GREEN COLLECTION PLANK

The design floors of CHECK green are convincing as oak-look planks. The robust, lightfast floor with its design and all-round 4V-groove not only ensures an attractive home, but

above all guarantees long-lasting quality. The installation is quick and conjures up a healthy feel-good atmosphere in all rooms in no time.



DIMENSIONS: 1285 x 192 mm
THICKNESS: 8.0 mm



2443 Zingsheim Oak
Skirting: 2443-L
Accessories colour: Silver grey

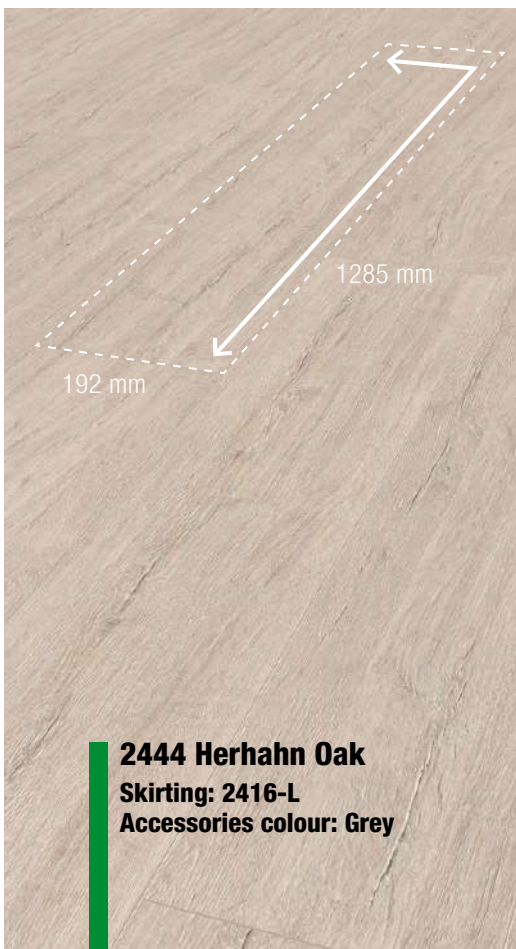

2444 Herhahn Oak
Skirting: 2416-L
Accessories colour: Grey



2446 Wetringen Oak
Skirting: 2044-L
Accessories colour: Oak



GREEN COLLECTION TILE

The CHECK green tiles are shown off to their best advantage in open-plan living areas, as their format creates a harmonious appearance. You can choose from an authentic

concrete and slate look with an all-round 4V-groove. This emphasises each individual tile and creates an elegant installation look.



DIMENSIONS: 635 x 327 mm
THICKNESS: 8.0 mm

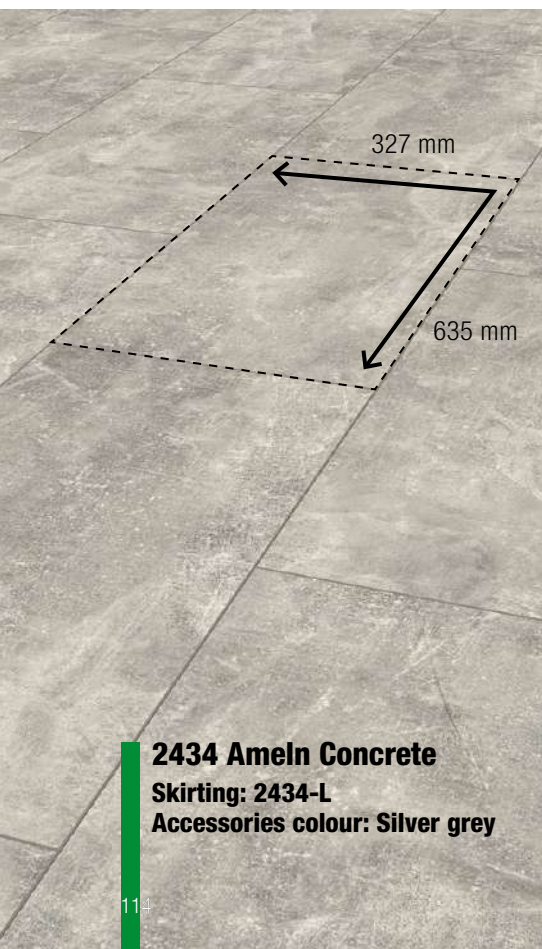

327 mm

635 mm

2434 Ameln Concrete
Skirting: 2434-L
Accessories colour: Silver grey



2435 Hochmoor Slate
Skirting: 5109-L
Accessories colour: Grey



2436 Lahde Slate
Skirting: 2124-L
Accessories colour: Silver grey



OUR TIP:
In damp rooms,
care should always
be taken to ensure that
a water-resistant floor
is laid.

2437 Lüre Slate
Skirting: 3079-L
Accessories colour: Black

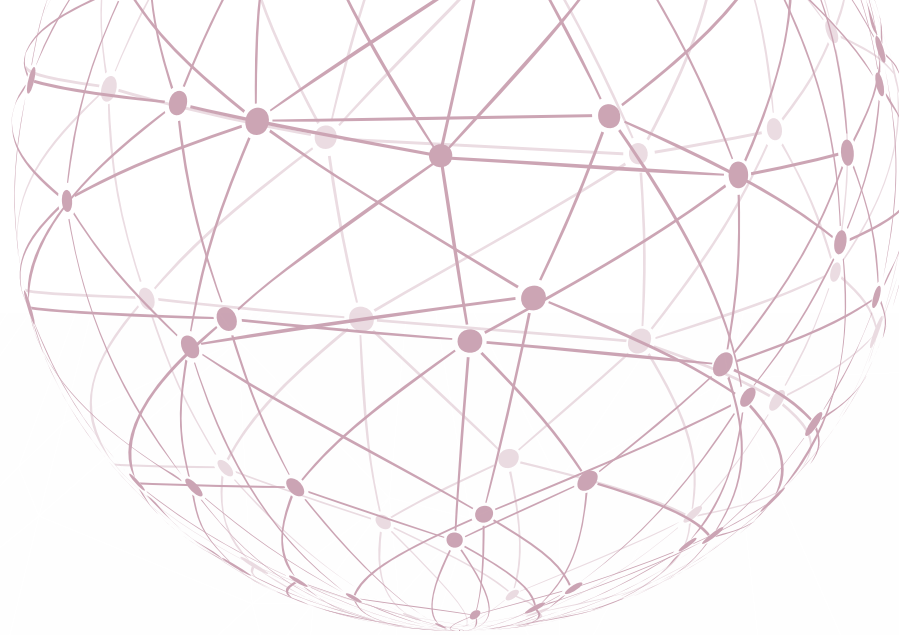

World of SPC & DRYBACK

by **CHECK** ✓

VINYLFLOORING

NEW WORLDS IN THE AREA OF HEALTHY LIVING VINYL FLOORS

Welcome to a new World of possibilities with our „World of SPC“ and „World of Dryback“ portfolio, opening up new horizons in the field of vinyl flooring. „World of SPC“ and „World of Dryback“ put the world at your feet. „With love from Germany“, the new portfolio offers a wide range of formats and designs fitted via click system and glued, all supplied with a 10-year guarantee.* The three

clearly defined collections of „Village“, „Town“ and „City“ offer a wide range of possibilities from entry level to heavy usage. Each offers something different within classic, wide and tile formats. Timeless and modern decors with 4V-groove options and the innovation of structured surfaces make the „World of SPC“ and „World of Dryback“ portfolio perfect for all your requirements.

WORLD OF SPC

The „World of SPC“ floors, laid using the click system, have a plasticizer-free mineral base and rigid carrier board, which not only offers superb stability, but is also resistant to heat and moisture. These floors are therefore particularly suitable for residential areas subject to heavy use and can be laid up to floor-to-ceiling windows, in conservatories, bathrooms and kitchens. These SPC Vinyl floors are also ideal for renovation and refurbishment work, such as installation over existing sub-floors due to their rigid backing plate and low installation height.

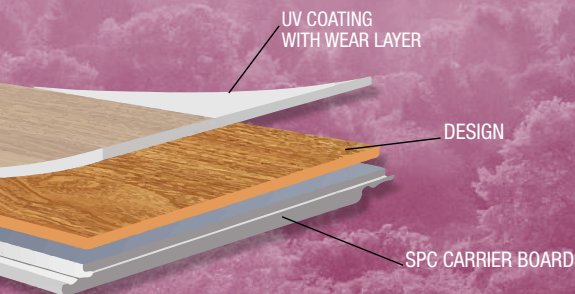

ADVANTAGES „WORLD OF SPC“

- suitable for wet rooms, residential conservatories and floor-to-ceiling windows**
- very hard-wearing
- low construction height
- plasticizer-free carrier board
- increased stability of the click connection
- suitable for underfloor heating*
- easy to clean

WORLD OF DRYBACK

The „World of Dryback“ collection includes water-resistant glued floors, which combine perfectly with hot water under-floor heating systems as the heat is particularly well conducted from the subfloor to the surface thanks to the full surface-wide connection. Due to the strong bond, no additional underlay for impact noise is required to reduce walking noise. In addition, there is nothing to prevent its use up to floor-to-ceiling windows, in residential conservatories, bathrooms and kitchens. Highly resistant and warm, Dryback floors bring such advantages as their low installation height, high load-bearing capacity and long service life as well as being phthalate-free, meaning, you can be safe in the knowledge you are protecting your home and the environment.

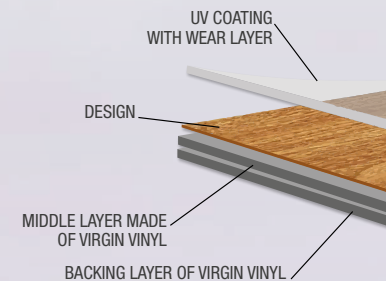

ADVANTAGES „WORLD OF DRYBACK“

- suitable for wet rooms, residential conservatories and floor-to-ceiling windows**
- extremely hard-wearing, resilient and durable
- very low construction height
- very easy to clean
- warm to the feet
- noise-free
- phthalate-free
- suitable for underfloor heating*

10 YEARS
GUARANTEE*

* according to guarantee conditions
** according to manufacturer approval

VILLAGE COLLECTION

The "Village Collection" offers a compact range with a 0.2 mm wear layer and utilisation class of 31. The perfect entry level range for light commercial and domestic use laid via the quick fitting click system.

VILLAGE COLLECTION – PLANK

dimension: 1220 x 180 x 3.2 mm

panels/box: 14 panels

sqm/box: 3.074

kg/box: approx. 20.59

boxes/pallet: 43

sqm/pallet: 132.20

Recommended utilisation class for private/commercial use:



3598 TAMPA OAK

EAN 4250055116461

click system: Loc-Click | wear layer: 0.2 mm



3598 TAMPA OAK

VILLAGE COLLECTION – PLANK

dimension: 1220 x 180 x 3.5 mm

panels/box: 12 panels

sqm/box: 2.635

kg/box: approx.18.83

boxes/pallet: 48

sqm/pallet: 126.49

Recommended utilisation class
for private/commercial use:



3539 SURPRISE OAK

EAN 4250055111961

skirting: 2416-L | accessories colour: Grey



3540 GILBERT OAK

EAN 4250055111978

skirting: 2036-L | accessories colour: Maple

click system: Loc-Click | wear layer: 0.2 mm

VILLAGE COLLECTION – PLANK INCL. INTEGRATED UNDERLAY

dimension: 1220 x 182 x 4.5 mm

planks/box: 10 panels

sqm/box: 2.220

kg/box: approx.15.76

boxes/pallet: 48

sqm/pallet: 106.579

Impact sound underlay



Recommended utilisation class
for private/commercial use:



3566 SEWARD OAK

EAN 4250055115860

skirting: 8127-L | accessories colour: Silver grey



3567 FERNDALE OAK

EAN 4250055115792

skirting: 2416-L | accessories colour: Grey



3568 GALENA OAK

EAN 4250055115808

skirting: 2002-L | accessories colour: Silver grey

click system: Loc-Click | wear layer: 0.2 mm



3540 GILBERT OAK

VILLAGE COLLECTION – PLANK INCL. INTEGRATED
CORK-UNDERLAY

dimension: 1220 x 180 x 4.5 mm

planks/box: 12 panels

sqm/box: 2.635

kg/box: approx. 19.93

boxes/pallet: 40

sqm/pallet: 105.41

cork impact sound underlay



Recommended utilisation class
for private/commercial use:



3565 MANCOS OAK

EAN 4250055115877

skirting: 3523-L | accessories colour: Oak



3569 SELIGMAN OAK

EAN 4250055115815

skirting: 8131-L | accessories colour: Walnut



3570 LEAVENWORTH OAK

EAN 4250055115822

skirting: 2002-L | accessories colour: Grey



3570 LEAVENWORTH OAK

TOWN COLLECTION

The „Town Collection“ expands the selection and introduces both wide and tile formats in addition to the classic with quick fitting click system. These three formats in an expanded selection of decors open up a myriad of options and possibilities. Thanks to the 4-5 mm thickness, 0.3 mm wear layer and utilisation class 32 this comprehensive portfolio of products can be laid in areas with average residential or commercial use. To add elegance to any area all boards are also supplied with a 4-sided bevel and 4V-groove. Some of the decors are also available as a dryback version for sticking.

TOWN COLLECTION – PLANK

dimension: 1220 x 180 x 4 mm

planks/box: 10 panels

sqm/box: 2.196

kg/box: approx. 17.77

boxes/pallet: 48

sqm/pallet: 105.41

bevelled
edge



Recommended utilisation class
for private/commercial use:

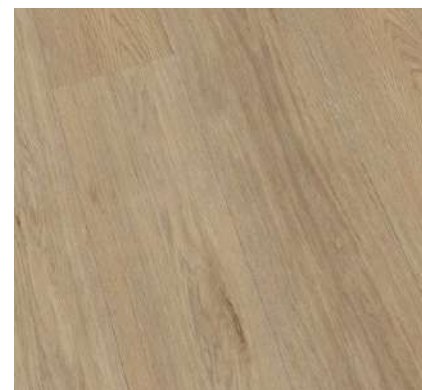

3504 SAN ANTONIO OAK

EAN 4250055109814

skirting: 3504-L | accessories colour: Maple



3505 SAN DIEGO OAK

EAN 4250055109821

skirting: 6501-L | accessories colour: Maple

TOWN COLLECTION – WIDE PLANK SPC

dimension: 1220 x 229 x 4 mm | planks/box: 8 panels
 sqm/box: 2.235 | kg/box: approx.17.88 | boxes/pallet: 48
 sqm/pallet: 107.28

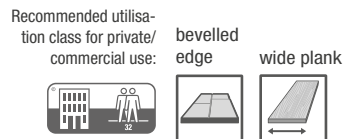
**TOWN COLLECTION – WIDE PLANK DRYBACK**

dimension: 1219 x 229 x 2.0 mm | planks/box: 12 panels
 sqm/box: 4.181 | kg/box: approx. 15.47 | boxes/pallet: 48
 sqm/pallet: 200.67

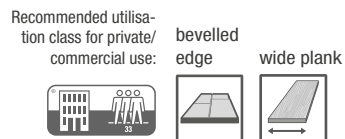
**AKRON OAK**

3535 EAN 4250055110810 (CLICK)
3535E EAN 4250055116362 (BONDING)
 skirting: 2045-L | accessories colour: Maple

**AMARILLO OAK**

3536 EAN 4250055110827 (CLICK)
3536E EAN 4250055116379 (BONDING)
 skirting: 2075-L | accessories colour: Maple

**AURORA OAK**

3537 EAN 4250055110834 (CLICK)
3537E EAN 4250055116386 (BONDING)
 skirting: 3073-L | accessories colour: Maple

**ALLEN OAK**

3541 EAN 4250055119165 (CLICK)
 skirting: 8155-L | accessories colour: Oak



3535 AKRON OAK

TOWN COLLECTION – TILE

dimension: 610 x 305 x 4 mm
 planks/box: 10 panels
 sqm/box: 1.861
 kg/box: approx.15.06
 boxes/pallet: 64
 sqm/pallet: 119.072

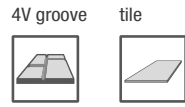

Recommended utilisation class
 for private/commercial use:



3511 INDIANAPOLIS SLATE

EAN 4250055109883
 skirting: 3511-L | accessories colour: Black
 click system: Loc-Click | wear layer: 0.3 mm



3512 SEATTLE CONCRETE

EAN 4250055109890
 skirting: 3512-L | accessories colour: Grey

TOWN COLLECTION – TILE INCL. INTERATED UNDERLAY

dimension: 620 x 310 x 5 mm
 planks/box: 10 panels
 sqm/box: 1.922
 kg/box: approx.16.61
 boxes/pallet: 60
 sqm/pallet: 115.320

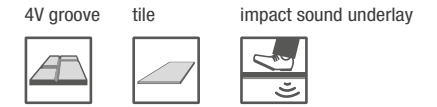

Recommended utilisation class
 for private/commercial use:



3579 BOLDER MARBLE

EAN 4250055115839
 skirting: 2124-L | accessories colour: Silver grey
 click system: Loc-Click | wear layer: 0.3 mm



3580 NEW HEAVEN MARBLE

EAN 4250055115853
 akirting: 2869-L | accessories colour: Black



3512 SEATTLE CONCRETE



3580 NEW HEAVEN MARBLE

TOWN COLLECTION – XL-TILE

dimension: 830 x 470 x 4 mm

planks/box: 6 panels

sqm/box: 2.341

kg/box: ca. 20.13

boxes/pallet: 48

sqm/pallet: 112.349

4V groove



XL-tile



Recommended utilisation class
for private/commercial use:

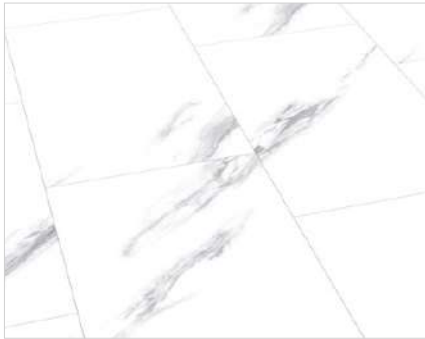

3578 FARGO MARBLE

EAN 4250055115846

skirting: 2143-L | accessories colour: White



3601 OMAHA CONCRETE

EAN 4250055117901



3602 WILTON CONCRETE

EAN 4250055117918

click system: Loc-Click | wear layer: 0.3 mm



3602 WILTON CONCRETE

1x4 COLLECTION

In the „1x4 Collection“ we present every stunning decor in 4 variations. The portfolio combines both SPC vinyl and Dryback options both in luxurious wide plank and classically appointed Herringbone formats. The SPC vinyl variations in click system installation style are available in 4 mm thickness with a 0.5 mm wear layer and utilisation class 41. The Dryback options offer 2.5 mm thickness with 0.5 mm wear layer and utilisation class 41. The finishing touch is a 4V-groove, which is located both lengthwise and widthwise around each board providing a striking but elegant appearance.

1x4 COLLECTION – WIDE PLANK SPC

dimension: 1220 x 228 x 4 mm | planks/box: 8 panels | sqm/box: 2.225
kg/box: approx.17.80 | boxes/pallet: 48 | sqm/pallet: 106.813

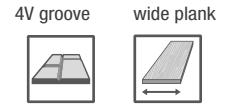

1x4 COLLECTION – WIDE PLANK DRYBACK

dimension: 1219 x 229 x 2.5 mm | planks/box: 16 panels | sqm/box: 4.466
kg/box: approx. 20.10 | boxes/pallet: 45 | sqm/pallet: 200.99

Recommended utilisation class
for private/commercial use:

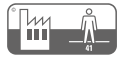

SAN FRANCISCO OAK

3524 EAN 4250055110582 (CLICK)
3524E EAN 4250055110629 (BONDING)
skirting: 2987-L | accessories colour: Maple



NEW ORLEANS OAK

3525 EAN 4250055110599 (CLICK)
3525E EAN 4250055110636 (BONDING)
skirting: 3525-L | accessories colour: Maple



ST. LOUIS OAK

3526 EAN 4250055110605 (CLICK)
3526E EAN 4250055110643 (BONDING)
skirting: 2002-L | accessories colour: Silver grey



SALT LAKE CITY OAK

3527 EAN 4250055110612 (CLICK)
3527E EAN 4250055110650 (BONDING)
skirting: 3527-L | accessories colour: Oak

click system: Loc-Click (SPC), bonding (Dryback) | wear layer: 0.5 mm

1x4 COLLECTION – HERRINGBONE SPC

dimension: 550 x 110 x 4 mm | planks/box: 26 panels | sqm/box: 1.573
kg/box: approx.12.58 | boxes/pallet: 72 | sqm/pallet: 113.26

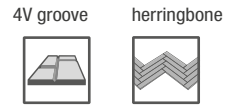

1x4 COLLECTION – HERRINGBONE DRYBACK

dimension: 600 x 120 x 2.5 mm | planks/box: 48 panels | sqm/box: 3.456
kg/box: approx.15.55 | boxes/pallet: 60 | sqm/pallet: 207.36

Recommended utilisation class
for private/commercial use:



SAN FRANCISCO OAK

3524H EAN 4250055110667 (CLICK)
3524HE EAN 4250055110704 (BONDING)
skirting: 2987-L | accessories colour: Maple



NEW ORLEANS OAK

3525H EAN 4250055110674 (CLICK)
3525HE EAN 4250055110711 (BONDING)
skirting: 3525-L | accessories colour: Maple



ST. LOUIS OAK

3526H EAN 4250055110681 (CLICK)
3526HE EAN 4250055110728 (BONDING)
skirting: 2002-L | accessories colour: Silver grey





SALT LAKE CITY OAK















3527H EAN 4250055110698 (CLICK)
3527HE EAN 4250055110735 (BONDING)
skirting: 3527-L | accessories colour: Oak



3526H(E) ST. LOUIS OAK

The collections at a glance

	FORMAT	IMPACT SOUND UNDERLAY	JOINT PATTERN	SURFACE	USEAGE CLASS	INSTALLATION	
BASIC COLLECTION	 Plank	✓	–	structure-embossed	31	Loc-Click	
	 Wide plank	✓	–	structure-embossed	32	Loc-Click	
CHECK ONE	STANDARD COLLECTION	 Plank	–	bevelled edge	structure-embossed	33	Loc-Click
		 Plank	✓	bevelled edge	structure-embossed	33	Loc-Click
		 Wide plank	–	4V groove	structure-embossed	34	Innovation-Click
		 Wide plank	✓	4V groove	structure-embossed	34	Loc-Click
	 Tile	–	4V groove	structure-embossed	33	Innovation-Click	
	 Tile	✓	4V groove	super matt-finish	33	Loc-Click	
	 XL-tile	✓	4V groove	super matt-finish	33	Loc-Click	
	PREMIUM COLLECTION	 Wide plank	–	bevelled edge	structure-embossed	42	Loc-Click
 Wide plank		✓	bevelled edge	structure-embossed	42	Innovation-Click	
 Herringbone		✓	bevelled edge	structure-embossed	42	Innovation-Click	
CHECK EXPERT	STANDARD COLLECTION	 Plank	–	–	structure-embossed	33	Bonding
		 Wide plank	–	bevelled edge	structure-embossed	42	Bonding
	PREMIUM COLLECTION	 Long & wide plank	–	bevelled edge	structure-embossed	42	Bonding
		 XL-tile	–	bevelled edge	structure-embossed	42	Bonding
CHECK COMFORT	COMFORT COLLECTION	 Wide plank SPC	✓	bevelled edge	structure-embossed	42	Innovation-Click
		 Long & wide plank SPC	✓	bevelled edge	structure-embossed	42	Innovation-Click
		 Wide plank ABA	✓	bevelled edge	synchronous embossed	42	Loc-Click
		 Long & wide plank ABA	✓	bevelled edge	synchronous embossed	42	Innovation-Click
CHECK GREEN	GREEN COLLECTION	 Plank 6 mm	–	4V groove	structure-embossed	32	One-Click
		 Plank 8 mm	–	4V groove	structure-embossed	33	One-Click
		 Tile	–	4V groove	structure-embossed	33	One-Click

	FORMAT	IMPACT SOUND UNDERLAY	JOINT PATTERN	SURFACE	USEAGE CLASS	INSTALLATION	
VILLAGE COLLECTION	 Plank	–	–	structure-embossed	31	Loc-Click	
	 Plank	✓	–	structure-embossed	31	Loc-Click	
World of SPC	TOWN COLLECTION	 Plank	–	bevelled edge	structure-embossed	32	Loc-Click
		 Wide plank	–	bevelled edge	structure-embossed	32	Innovation-Click
		 Wide plank	–	bevelled edge	structure-embossed	33	Bonding
		 Wide plank	–	4V groove	structure-embossed	32	Loc-Click
	World of DRYBACK	 Tile	–	4V groove	structure-embossed	32	Loc-Click
		 Tile	✓	4V groove	structure-embossed	32	Loc-Click
		 XL-tile	–	4V groove	structure-embossed	32	Loc-Click
		 Wide plank	–	4V groove	structure-embossed	41	Loc-Click
1X4 COLLECTION	 Wide plank	–	4V groove	structure-embossed	41	Bonding	
	 Herringbone	–	4V groove	structure-embossed	41	Push-Click	
	 Herringbone	–	4V groove	structure-embossed	41	Bonding	
	 Herringbone	–	4V groove	structure-embossed	41	Bonding	

BY CHECK



Order **free samples** of our CHECK products online now at **check-floors.com!**



CHECK installation options

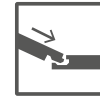

LOC-CLICK

With the Loc-Click connection, row by row is clicked into the previous one on the long side. This is done by angling the long side under slight pressure until it clicks into place. The row is then connected to the previous one.



ONE-CLICK

With this click connection, a row is first created over the entire width of the room by clicking together at the front. The next row is clicked into the groove profiling of the previous row on the long edge. To lock, the plank is angled downwards and snapped in with pressure from above until an audible click is heard.



INNOVATION-CLICK

With this click system, each board can be laid individually. The long side is angled, then the panel is lowered and the overlapping end faces are connected by tapping with a rubber hammer, so that the surface is level. The click connection is a particularly stable connection because, contrary to other "drop-down" connections, it is not only inserted or pressed in, but locked in three positions in the tongue and groove and hammered into place.



BONDING

Using this technique, the floor is glued over the entire surface using an adhesive. The individual planks are glued to the walls without tension and without joints. With regard to adhesive processing, the adhesive manufacturer's specifications and instructions must be observed.



The click connections are ideally suited for floating installation on their own. Detailed installation instructions can be found on the back of each box, at [check-floors.com](https://www.check-floors.com) or as videos on our YouTube channel.

Formats & joint pattern

FORMATS

Our floors are available in different formats, with six variants to choose from: plank, wide plank, long & wide plank, herringbone, tile and XL-tile format.

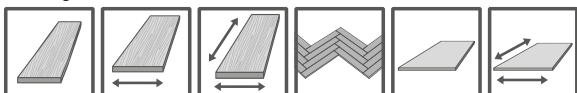

GROOVES & BEVELLS



4V GROOVE | Grooves frame the individual planks and define the surface appearance of the floor. The lacquered 4V grooves lie both lengthways and transversely around the individual plank, making each plank strikingly visible.



BEVELLED EDGE | A bevel is understood to mean the slight chamfering of an edge. With a 4-sided bevel, each individual plank is slightly accentuated visually.

WITHOUT GROOVES | Planks without grooves show no gaps, resulting in a calm, harmonious appearance.





Special features



INCL. UNDERLAY | The decor is already equipped with impact sound insulation on the underside of the carrier and thus enables quick installation.



MATT | The matt surface gives the decor a natural and real look and makes it appear even more real.



SUPER MATT | The natural-looking super matt surface creates a particularly modern, authentic and exclusive room atmosphere.



HIGH GLOSS | A high gloss surface on vinyl gives the material an elegant, shiny look that makes colours appear more intense and at the same time provides a smooth, easy-to-clean surface.



SYNCHRONPRÄGUNG | Synchronised embossing on vinyl is particularly attractive as it perfectly reproduces the natural wood grain, creating an authentic, high-quality look and a realistic feel.

UTILISATION CLASSES (UC)

	PRIVATE USE	COMMERCIAL USE	INDUSTRIAL USE
LIGHT			
MEDIUM			
STRONG			
EXTRA STRONG			

»EQUIPPED«

For a perfect finish

So that the pleasure of your new floor lasts, it is of great importance to choose the right accessories. The brand **EQUIPPED** offers a wide range of impact sound underlays, skirtings, clip systems and corners.

The impact sound range includes four different insulation underlays for vinyl floors, which are available in thicknesses

of 1.0 mm and 1.2 mm. There is also a skirting board for every CHECK floor that matches the decor or is white (paintable) and offers the option of concealing a cable behind it. Rounded off by end caps on projections or door frames as well as connectors and inner corners, the range offers everything needed to complete the installation.

All corners, connectors and end caps are available in the following colours:

			
Maple	Beech	Oak	Grey
			
Walnut	Silver Grey	Black	White



VARIOUS WHITE SKIRTING

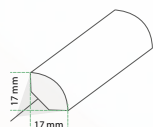

0032
Quarter stick
Length 2,500 mm
EAN 4250055101740

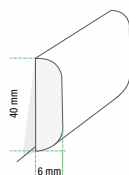

0034
Skirting white 40 mm
Length 2,600 mm
EAN 4250055116300

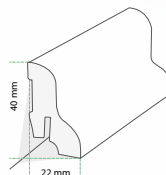

0026
Skirting white 40 mm
Length 2,400 mm
EAN 4250055101740



0027
Skirting white 58 mm
Length 2,400 mm
EAN 4250055101405

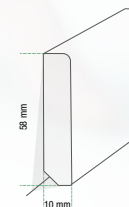

0035
Skirting white 58 mm
Length 2,400 mm
EAN 4250055116317

2935
Gloss skirting white 58 mm
Length 2,400 mm
EAN 4250055100163

← In addition to the matching decorative **EQUIPPED** skirtings in 58 mm height and 2,400 mm length, there are other **white skirtings** in the following formats:

WEIMARER SKIRTINGS

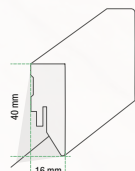

0036
Weimarer skirting 40 mm
Length 2,500 mm
EAN 4250055116331

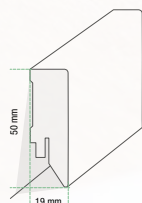

0037
Weimarer skirting 50 mm
Length 2,500 mm
EAN 4250055116348

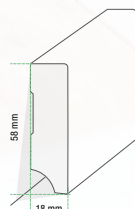

0038
Weimarer skirting 58 mm
Length 2,400 mm
EAN 4250055116324

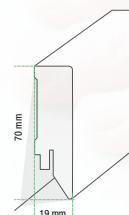

0039
Weimarer skirting 70 mm
Length 2,500 mm
EAN 4250055116355

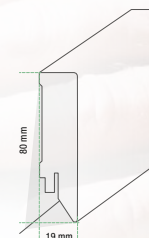

0030
Weimarer skirting 80 mm
Length 2,500 mm
EAN 4250055101726

BERLINER SKIRTINGS

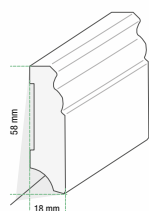

0040
Berliner skirting 58 mm
Length 2,400 mm
EAN 4250055116447

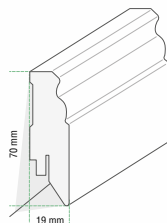

0029
Berliner skirting 70 mm
Length 2,500 mm
EAN 4250055101719

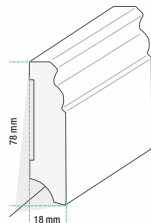

0041
Berliner skirting 78 mm
Length 2,400 mm
EAN 4250055116454

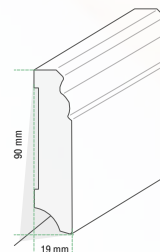

0031
Berliner skirting 90 mm
Length 2,500 mm
EAN 4250055101733



” We ensure that your new floor and the right accessories arrive on time for installation. “
Gerd Buhs, Logistic Manager



1016
SOFT SOUND



1012
PRO SOUND



1009
V-SOUND



1020
V-PREMIUM SOUND

Product	EAN	4250055108466	4250055105366
	Strength	1.20 mm	1.00 mm
	Content	1 x 15 m = 15 sqm	1.18 x 8.5 m = 10.03 sqm
	Surface weight	0.15 kg/sqm	0.19 kg/sqm
	Material	Polyester fibre fleece	XPS / PET
	Area of application	Click-vinyl floors / Design floors	Click-vinyl floors / Design floors
	Delivery form	Roll	Folding panel
	Pallet size	40 rolls = 600 sqm	42 pack = 421.26 sqm
Acoustics	Impact sound reduction (IS)	18 dB	15 dB
	Walking sound insulation (RWS)	–	–
Use	Pressure stress (CS)	400 kPa	400 kPa
	Dynamic load (DL)	–	> 400.000 cycles
	Fire behaviour (RTF)	Efl	Efl
Sub floor	Thermal resistance (R)	0.024 sqm K/W	0.03 sqm K/W
	Compensation capability (PC)	> 0.50 mm	0.80 mm
	Moisture protection (SD)	–	> 75 m

	4250055104338	4250055112715
	1.00 mm	1.00 mm
	1 x 12.5 m = 12.5 sqm	1 x 10 m = 10 sqm
	0.23 kg/sqm	1.20 kg/sqm
	Polyolefin (PO)	Polyurethane (PU) / fleece
	Click-vinyl floors / Design floors	Click-vinyl floors / Design floors
	Roll	Roll
	64 rolls = 800 sqm	54 rolls = 540 sqm
	18 dB	Up to 15 dB
	40 %	up to 12 %
	490 kPa	> 750 kPa
	> 250.000 cycles	> 3.000,000 cycles
	Efl	Efl
	0.02 sqm K/W	0.01 sqm K/W
	≥ 0.50 mm	≈ 0.20 mm
	> 75 m	–



check-floors.com

CHECK ✓

VERSION 1/2024

Our team is here for you.

Send us your requirements and we will solve them.

Our logistics and sales network can handle almost any task.

CHECK is a brand of:

Koczwara Vertriebs-GmbH | Scheuten-Solar-Straße 2 | 45881 Gelsenkirchen | GERMANY

check-floors.com

Errors and modifications excepted. The colour representation of the decors in this brochure may differ from the original decors.

© Image sources including Koczwara, Adobe Stock